

APPENDIX B: Water Heating Calculation Method

B1. Purpose and Scope

This appendix documents the methods and assumptions used for calculating the hourly energy use for residential water heating systems for the proposed design and the standard design. The hourly fuel and electricity energy use for water heating will be combined with hourly space heating and cooling energy use to come up with the hourly total fuel and electricity energy use to be factored by the hourly time-dependent valuation (TDV) energy multiplier. The calculation procedure applies to low-rise single-family, low-rise multifamily, and high-rise residential.

Calculations are described below for gas and electric water heaters. The internal water heater modeling is performed within the California Simulation Engine (CSE). The compliance modeling rules documented here are implemented in the (California Building Energy Code Compliance) CBECC-Res ruleset and determine the input values passed to CSE.

When buildings have multiple water heaters, the hourly total water heating energy use is the hourly water heating energy use summed over all water heating systems, all water heaters, and all dwelling units being modeled.

The following diagrams illustrate the domestic hot water (DHW) system distribution types that shall be recognized by the compliance software.

Table B-1: Distribution Systems Within a Dwelling Unit with One or More Water Heaters

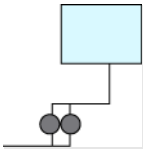
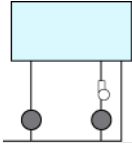
| Option # | Description | Diagram |
|----------|--|--|
| 1 | One distribution system with one or multiple water heaters serving a single dwelling unit. The system might include recirculation loops within the dwelling unit. |  |
| 2 | Two water heaters with independent distribution systems serving a single dwelling unit. One or more of the distribution systems may include a recirculation loop within the dwelling unit. |  |

APPENDIX B — Water Heating Calculation Method

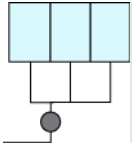
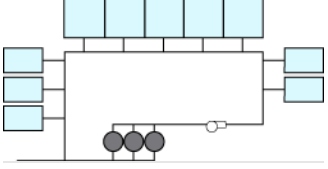
| Option # | Description | Diagram |
|----------|--|--|
| 3 | One distribution system without recirculation loop and with one or multiple water heaters serving multiple dwelling units. |  |
| 4 | One distribution system with one or multiple recirculation loops and with one or multiple water heaters serving multiple dwelling units. |  |

Source: California Energy Commission

B2. Water Heating Systems

Water heating distribution systems may serve more than one dwelling unit and may have more than one water heater and more than one water heating system. The energy used by a water heating system is calculated as the sum of the energy used by each water heater in the system. Energy used for the whole building is calculated as the sum of the energy used by each of the water heating systems. To calculate the energy used by each water heater and water heating system, the following variables are used.

CFA — Conditioned floor area, ft², of the building.

NFloor — Number of floors in the building

Nunit — Number of dwelling units in the building

NK — Number of water heating systems in the building

NWH_k — Number of water heaters in the kth system

NLoop_k — Number of recirculation loops in the kth system (multiunit dwellings only)

CFA_i — Conditioned floor area of the ith dwelling unit, ft²

CFAU_k — Average dwelling unit conditioned floor area served by kth system, ft²

NL_k — number of unfired- or indirectly fired storage tanks in the kth system

B3. Hot Water Consumption

The schedule of hot water use that drives energy calculations is derived from measured data as described in Appendix F (Kruis, 2019). That analysis produced 365 day sets of fixture water draw events for dwelling units having a range of number of bedrooms. The draws are defined in the file DHWDU.TXT (for single-family) that installs with CBECC-Res. Each draw is characterized by a start time, duration, flow rate, and end use. The flow rates given are the total flow at the point of use (fixture or appliance). This detailed representation allows

APPENDIX B — Water Heating Calculation Method

derivation of draw patterns at 1-minute intervals as is required for realistic simulation of heat pump water heaters.

The fixture flow events are converted to water heater (hot water) draws by (1) accounting for mixing at the point of use and (2) accounting for waste and distribution heat losses:

$$VSk = VDk \times \int dur \times VQk \times \int hotV \quad \text{Equation 1}$$

Where

VSk = Hot water draw at the k^{th} water heating system's delivery point (gal)

VDk = Mixed water draw duration at an appliance or fixture (min) served by the k^{th} water heating system, as specified by input schedule

VQk = Mixed water flow at an appliance or fixture (gpm) served by the k^{th} water heating system, as specified by input schedule

f_{hot} , f_{dur} , f_q = End-use-specific factors from the following:

Shower/bath

$$f_{hot} = \frac{105 - T_{inlet}}{T_s - T_{inlet}}$$

$$f_{dur} = WF_k \times DLM_k$$

Faucet

$$f_{hot} = 0.50$$

$$f_{dur} = 1$$

Clothes washer

$$f_{hot} = 0.22$$

$$f_{dur} = 1$$

Dish washer

$$f_{hot} = 1$$

$$f_{dur} = 1$$

T_s = Hot water supply temperature (°F); assumed to be 115°F

T_{inlet} = Cold water inlet temperature (°F) as defined in Section B1.2. Note that T_{inlet} may be tempered by drain water heat recovery (DWHR).

WF_k = Hot water waste factor

- $WF_k = 0.9$ for within-dwelling-unit pumped circulation systems (see Table B-1)
- $WF_k = 1.0$ otherwise

APPENDIX B — Water Heating Calculation Method

DLM_k = Distribution loss multiplier (unitless), see *Equation 5*

The individual water heater draws are combined to derive the overall demand for hot water.

For each hour of the simulation, all water heater draws are allocated to 1-minute bins using the starting time and duration of each draw. This yields a set of 60 $VS_{k,t}$ values for each hour that is used as input to the detailed heat pump water heater (HPWH) and instantaneous water heater models in later sections. For hourly efficiency-based models used for some water heater types, the minute-by-minute values are summed to give an hourly hot water requirement:

$$GPH_k = \sum_{t=1}^{60} VS_{k,t} \quad \text{Equation 2}$$

In cases where multiple dwelling units are served by a common water heating system, the dwelling unit draws are summed.

In cases where there are multiple water heating systems within a dwelling unit, the draws are divided equally among the systems. For minute-by-minute draws, this allocation is accomplished by assigning draws to systems in rotation within each end use weighted by the number of fixtures of each type are served by each system. This assignment ensures that some peak draw events within each end use get assigned to each system. Since heat pump water heater performance is nonlinear with load (due to activation of resistance backup), allocation of entire events to systems is essential. The assignment scheme allocates draws by end use as opposed to specific draws to specific systems. Explicit draw assignment would require plumbing layout information — capturing that is deemed to impose an unacceptable user input burden.

B4. Hourly Adjusted Recovery Load

The hourly adjusted recovery load for the k th water heating system is calculated as:

$$HARL_k = HSEU_k + HRDL_k + \sum_1^{NL_k} HJL_l \quad \text{Equation 3}$$

Where

$HSEU_k$ = Hourly standard end use at all use points (Btu), see Equation 4

$HRDL_k$ = Hourly recirculation distribution loss (Btu), see Equation 14

15; $HRDL_k$ is nonzero only for multifamily central water heating systems

NL_k = Number of unfired or indirectly fired storage tanks in the k^{th} system

HJL_l = Tank surface losses of the l^{th} unfired tank of the k^{th} system (Btu), see Equation 4345

Equation 4 calculates the hourly standard end use (HSEU). The heat content of the water delivered at the fixture is the draw volume in gallons (GPH) times the temperature rise DT (difference between the cold water inlet temperature and the hot water supply temperature) times the heat required to elevate a gallon of water 1°F (the 8.345 constant).

APPENDIX B — Water Heating Calculation Method

$$HSEU_k = 8.345 \times GPH_k \times (T_s - T_{inlet}) \quad \text{Equation 4}$$

Where

HSEU_k = Hourly standard end use (Btu)

GPH_k = Hourly hot water consumption (gallons) from *Equation 2*

Equation 5 calculates the distribution loss multiplier (DLM), which combines the standard distribution loss multiplier (SDLM), which depends on the floor area of the dwelling unit and the distribution system multiplier (DSM).

$$DLM_k = 1 + (SDLM_k - 1) \times DSM_k \quad \text{Equation 5}$$

Where

DLM_k = Distribution loss multiplier (unitless)

SDLM_k = Standard distribution loss multiplier (unitless). See *Equation 6*

DSM_k = Distribution system multiplier (unitless). See Section Distribution Losses Withing the Dwelling Unit. Several relationships depend on CFA_k, the floor area served (see below).

Equation 6 calculates the standard distribution loss multiplier (SDLM) based on dwelling unit floor area. In *Equation 6*, that floor area CFAU_k is capped at 2500 ft². Without that limit, *Equation 6* produces unrealistic SDLM_k values for large floor areas.

$$SDLM_k = 1.0032 + 0.0001864 \times CFAU_k - 0.00000002165 \times CFAU_k^2 \quad \text{Equation 6}$$

Where

SDLM_k = Standard distribution loss multiplier (unitless).

CFAU_k = Dwelling unit conditioned floor area (ft²) served by the kth system, calculated using methods specified in *Equation 7*.

Single dwelling unit,

$$CFAU_k = CFA/NK$$

For multiple dwelling units served by a central system:

$$CFAU_k = \frac{\sum_{\text{all units served by system } k} CFA_i}{N_{unit_k}}$$

Alternatively, if the system-to-unit relationships not known:

$$CFAU_k = \frac{\sum_{\text{all units served by any central system}} CFA_i}{\text{Number of units served by any central system}} \quad \text{Equation 7}$$

Method WH-

CFAU

Note: "Method" designations are invariant tags that facilitate cross-references from comments in implementation code.

APPENDIX B — Water Heating Calculation Method

When a water heating system has more than one water heater, the total system load is assumed to be shared equally by each water heater, as shown in *Equation 8*.

$$HARL_j = \frac{HARL_k}{NWH_k} \quad \text{Equation 8}$$

Where

$HARL_j$ = Hourly adjusted recovery load for the j^{th} water heater of the k^{th} system (Btu)

$HARL_k$ = Hourly adjusted total recovery load for the k^{th} system (Btu)

NWH_k = The number of water heaters in the k^{th} system

Distribution Losses Within the Dwelling Unit

The distribution system multiplier (DSM, unitless) is an adjustment for alternative water heating distribution systems within the dwelling unit. A DSM value of 1.00 will be reached in “standard” distribution systems, defined as a nonrecirculating system, with the full length of distribution piping insulated in accordance with Section 150.0(j)2.

$$DSM_k = ADSM_k \times CF_k \quad \text{Equation 9}$$

Where

$ADSM_k$ = Assigned Distribution System Multiplier, see below.

CF_k = Compactness factor (unitless), default value is 1.0, calculated according to Section 5.6.2.4 of the *Residential Compliance Manual*.

ADSM values for alternative distribution systems are given in Table B-1. Improved ADSM values are available for cases where voluntary HERS inspections are completed, as per the eligibility criteria shown in Reference Residential Appendix RA4.4. Detailed descriptions of all of the distribution system measures are found in Residential Appendix RA 4.4.

Table B-2: Distribution System Multipliers Within a Dwelling Unit With One or More Water Heaters

| Distribution System Types | Assigned Distribution System Multiplier (ADSM) | System Types 1 and 2 | System Type 3 and 4 |
|---|--|----------------------|---------------------|
| No HERS Inspection Required | | | |
| Trunk and Branch -Standard (STD) | 1.0 | Yes | Yes |
| Central Parallel Piping (PP) | 1.10 | Yes | |
| Point of Use (POU) | 0.30 | Yes | |
| Recirculation: Nondemand Control Options (R-ND) | 9.80* | Yes | |
| Recirculation with Manual Demand Control (R-DRmc) | 1.75* | Yes | |
| Recirculation with Motion Sensor Demand Control (R-DRsc) | 2.60* | Yes | |
| Optional Cases: HERS Inspection Required | | | |
| Pipe Insulation (PIC-H) | 0.85 | Yes | Yes |
| Central Parallel Piping with 5' maximum length (PP-H) | 1.00 | Yes | |
| Compact Design (CHWDS-H) | 0.70 | Yes | |
| Recirculation with Manual Demand Control (R-DRmc-H) | 1.60* | Yes | |
| Recirculation with Motion Sensor Demand Control (RDRsc-H) | 2.40* | Yes | |

***Recirculation ADSMs reflect the effect of reduced hot water consumption associated with recirculation systems.**

Source: California Energy Commission

Cold Water Inlet Temperature

The water heater inlet temperature is assumed to vary daily and depends on mains water temperature, drain water heat recovery, and solar preheating.

For each day of the year, T_{mains} is calculated as follows:

$$T_{main} = T_{ground} \times 0.65 + T_{avg31} \times 0.035 \qquad \text{Equation 10}$$

APPENDIX B — Water Heating Calculation Method

T_{avg31} = Outdoor dry-bulb temperature averaged over all hours of the previous 31 days (for January days, weather data from December will be used.)

T_{ground} = Ground temperature (°F) for current day of year, calculated using: *Equation 11*.

each day (q = 1 TO 365)

$$T_{ground}(\theta) = TyrAve - 0.5 \times (TyrMax - TyrMin) \times \cos(2 \times \pi \times ((\theta - 1)/PB) - PO - PHI) \times GM$$

Equation 11

Where

TyrAve = average annual temperature, °F

TyrMin = the lowest average monthly temperature, °F

TyrMax = the highest average monthly temperature, °F

PB = 365

PO = 0.6

DIF = 0.025 ft²/hr

BETA = $\text{SQR}(p/(DIF \cdot PB \cdot 24)) \cdot 10$

XB = $\text{EXP}(-BETA)$

CB = $\text{COS}(BETA)$

SB = $\text{SIN}(BETA)$

GM = $\text{SQR}((XB \cdot XB - 2 \cdot XB \cdot CB + 1)/(2 \cdot BETA \cdot BETA))$

PHI = $\text{ATN}((1 - XB \cdot (CB + SB)) / (1 - XB \cdot (CB - SB)))$

The water heater inlet temperature, T_{inlet} , is calculated as follows:

$$T_{inlet} = (1 - SSF_k)(T_{mains} + \Delta T_{dwhr}) + SSF_k \times T_s$$

Equation 11

Where

SSF_k = Solar savings fraction for kth system (see below), unitless

ΔT_{dwhr} = Water temperature increase due to drain water heat recovery, °F (0 if no DWHR). See Section Drain Water Heat Recovery.

T_s = Hot water supply temperature

All water heaters in a water heating system are assumed to have the same T_{inlet} .

The hourly solar savings fraction for the kth water heating system, SSF_k , is the fraction of the total water heating load that is provided by solar hot water heating. The annual average value for SSF is provided from the results generated by the California Energy Commission-

APPENDIX B — Water Heating Calculation Method

approved calculations approaches for the OG-100 and OG-300 test procedure. A Commission-approved method shall be used to convert the annual average value for SSF to hourly SSFk values for use in compliance calculations.

Drain Water Heat Recovery

Drain water heat recovery (DWHR) devices are heat exchangers that transfer heat from warm drain water to incoming cold (mains) water. These operate on draws where supply and drain flow are simultaneous — for example, showers (as opposed to dishwashers). In CBECC-Res, only shower draws support DWHR. Several plumbing configurations are possible.

Figure 1: Heat Exchanger Output Connected to Both Shower Water Heater Cold Sides

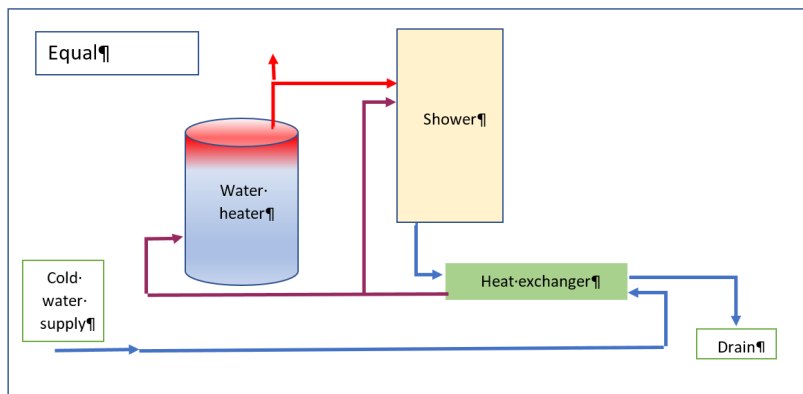

Source: California Energy Commission

Figure 2: Heat Exchanger Output Connected to Water Heater Cold Side

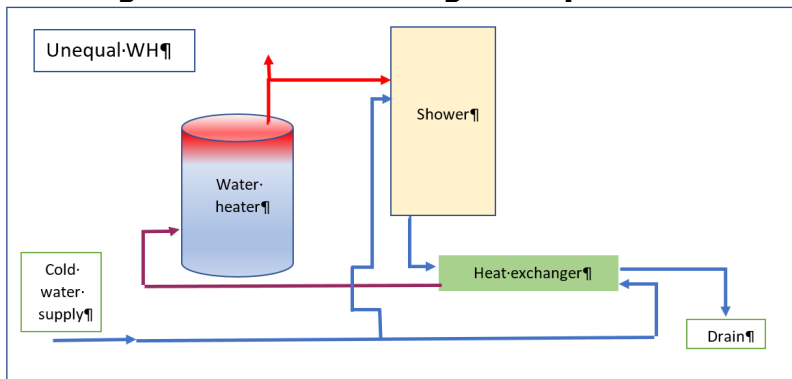

APPENDIX B — Water Heating Calculation Method

Source: California Energy Commission

Figure 3: Heat Exchanger Output Connected to Shower Cold Side

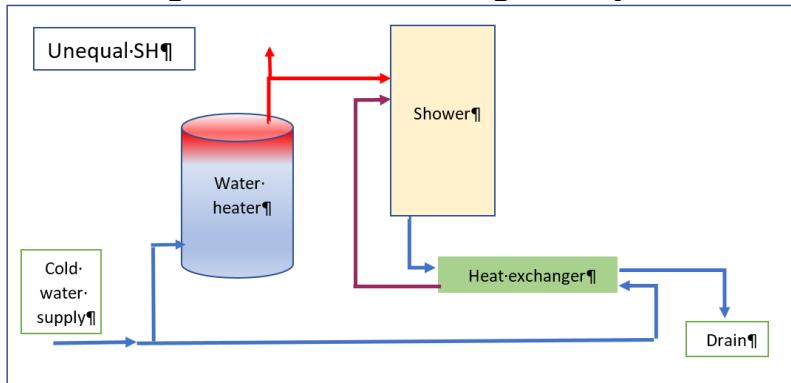

Source: California Energy Commission

Figure 4: Heat Exchanger Output Connected to Both Shower Water Heater Cold Side

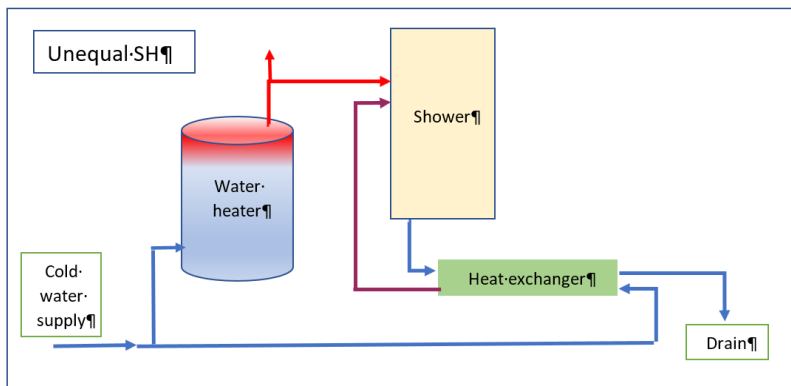

Source: California Energy Commission

In practice, there are many combination plumbing configurations that are possible. For example, only some showers may drain via DWHR devices, or more than one shower may drain via a shared DWHR device. CBECC-Res input structure allows flexible specification of such arrangements.

The drain water heat recovery temperature increase, ΔT_{dwhr} , is modeled within CSE using effectiveness derived using correlations presented in:

- [Drain Water Heat Recovery – Final Report](http://title24stakeholders.com/wp-content/uploads/2017/09/2019-T24-CASE-Report_DWHR_Final_September-2017.pdf). Measure Number: 2019-RES-DHW2-F. Available at http://title24stakeholders.com/wp-content/uploads/2017/09/2019-T24-CASE-Report_DWHR_Final_September-2017.pdf
- *Explanation of Drain Water Heat Recovery Calculations*. NegaWatt Consulting. Dec. 13, 2017.

APPENDIX B — Water Heating Calculation Method

DWHR is supported only for shower draws. Based on experimental data, the effectiveness correlation is function of potable water flow rate, potable water entering temperature, and drain water flow rate, as shown here:

$$\begin{aligned}
 t_{pi} &= \min(t_{mains}, 81) \\
 f_t &= \left(-3.06 \times 10^{-5} t_{pi}^2 + 4.96 \times 10^{-3} t_{pi} + 0.281 \right) / 0.466 \\
 f_v &= -6.98484455 \times 10^{-4} v_p^4 + 1.28561447 \times 10^{-2} v_p^3 - 7.02399803 \times 10^{-2} v_p^2 \\
 &\quad + 1.33657748 \times 10^{-2} v_p + 1.23339312 \\
 \varepsilon &= \left[0, \left(1 + 0.3452 \ln(v_d/v_p) \right) f_t f_v \varepsilon_{rated}, 0.95 \right]
 \end{aligned}
 \tag{Equation 12}$$

Where

t_{pi} = DWHR potable water inlet temperature, °F

v_p = Potable volume flow rate, gpm. v_p depends on the plumbing configuration and is various combinations of the fixture hot water draw, the fixture cold water draw, and the total hot water draw.

v_d = Drain volume flow rate, gpm. The drain volume is equal to the total (mixed) draws of fixture(s) evaluated *not including* f_{dur} (see Equation 1) since no heat can be recovered during warmup.

e = DWHR effectiveness under current conditions, unitless

ε_{rated} = DWHR-rated effectiveness = efficiency/100, rated at CSA B55.1 conditions (9.5 lpm, equal flow)

The effectiveness, e , is used to calculate the potable water temperature increase.

$$\Delta T_{dwhr} = \frac{\varepsilon \min(v_p, v_d) (t_d - t_{pi})}{v_p}
 \tag{Equation 13}$$

Where

t_d = DWHR drain-side entering temperature, °F = shower use temperature (105°F) – 4.6°F. The latter adjustment approximates heat loss between the shower and the DWHR device.

In this model with some plumbing configurations, effectiveness depends on v_p , and v_p depends on effectiveness. An iterative solution technique is required to find consistent conditions.

When only some shower fixtures within a dwelling unit drain via a DWHR system, savings are assumed proportional to the number of included shower fixtures. This is implemented by assigning shower draws in rotation to DWHR or non-DWHR arrangements.

B5. Hourly Distribution Loss for Central Water Heating Systems

This section is applicable to the DHW system Types 3 and 4, as defined in B1. The distribution losses accounted for in the distribution loss multiplier (DLM), Equation 5, reflect distribution heat loss within each dwelling unit. Additional distribution losses occur outside dwelling units and include losses from recirculation loop pipes and branch piping feeding dwelling units. The hourly values of these losses, HRDL, shall be calculated according to Equation 17. Compliance software shall provide input for specifying recirculation system designs and controls according to the following algorithms.

$$HRDL_k = NLoop_k \times HRLL_k + HRBL_k \quad \text{Equation 14}$$

Where

HRDL_k= Hourly central system distribution loss for kth system (Btu).

HRLL_k= Hourly recirculation loop pipe heat loss (Btu). This component is only applicable to system Type 4, see Equation 15

HRBL_k= Hourly recirculation branch pipe heat loss (Btu), see Equation 23
 NLoop_k= Number of recirculation loops in water heating system k; this component is only applicable to system Type 4, see Section Drain Water Heat Recovery.

A recirculation loop usually includes multiple pipe sections, not necessarily having the same diameter, that are exposed to different ambient conditions. The compliance software shall provide input entries for up to six pipe sections, with three sections for supply piping and three sections for return piping for users to describe the configurations of the recirculation loop. For each of the six pipe sections, input entries shall include pipe diameter (inch), pipe length (ft), and ambient conditions. Ambient condition input shall include three options: outside air, underground, conditioned or semi conditioned air. Modeling rules for dealing with recirculation loop designs are provided in Section Drain Water Heat Recovery.

Outside air includes crawl spaces, unconditioned garages, unconditioned equipment rooms, as well as the actual outside air. Solar radiation gains are not included in the calculation because the effect of radiation gains is relatively minimal compared to other effects. Furthermore, the differences in solar gains for the various conditions (for example, extra insulation vs. minimum insulation) are even less significant.

The ground condition includes any portion of the distribution piping that is underground, including that in or under a slab. Insulation in contact with the ground must meet all the requirements of Section 150.0(j), Part 6, of Title 24.

The losses to conditioned or semi conditioned air include losses from any distribution system piping that is in an attic space, within walls (interior, exterior, or between conditioned and unconditioned spaces), within chases on the interior of the building, or within horizontal spaces between or above conditioned spaces. It does not include the pipes within the residence. The distribution piping stops at the point where it first meets the boundaries of the dwelling unit.

Hourly Recirculation Loop Pipe Heat Loss Calculation

Hourly recirculation loop pipe heat loss (HRL_{Lk}) is the hourly heat loss from all six pipe sections. There are two pipe heat loss modes — pipe heat loss with nonzero water flow (PLWF) and pipe heat loss without hot water flow (PLCD). The latter happens when the recirculation pump is turned off by a control system and there are no hot water draw flows, such as in recirculation return pipes.

Compliance software shall provide four options of recirculation system controls listed in Table B-3 or Table B-4. A proposed design shall select a control type from one of the four options. The standard design shall use demand control.

Table B-3: Recirculation Loop Supply Temperature and Pump Operation Schedule (With No Control or Demand Control)

| Hour | No Control Temperature | No Control Input for SCH _{k,m} | Demand Control Temperature | Demand Control Input for SCH _{k,m} |
|--------------|------------------------|---|----------------------------|---|
| 1 through 24 | 130 | 1 | 130 | 0.2 |

Source: California Energy Commission

Table B-4. Recirculation Loop Supply Temperature and Pump Operation Schedule (With Temperature Modulation Control)

| Hour | Without Continuous Monitoring Temperature | Without Continuous Monitoring Input for SCH _{k,m} | With Continuous Monitoring Temperature | With Continuous Monitoring Input for SCH _{k,m} |
|--------------|---|--|--|---|
| 1 through 5 | 120 | 1 | 115 | 1 |
| 6 | 125 | 1 | 120 | 1 |
| 7 through 23 | 130 | 1 | 125 | 1 |
| 24 | 125 | 1 | 120 | 1 |

Source: California Energy Commission

Pipe heat loss modes are determined by recirculation control schedules and hot water draw schedules. For each pipe section, hourly pipe heat loss is the sum of heat loss from the two heat loss modes.

Hourly heat loss for the whole recirculation loop (HRL_k) is the heat loss from all six pipe sections, according to the following equation:

$$HRL_k = \sum_n [PLWF_n + PLCD_n] \quad \text{Equation 15}$$

Where

PLWF_n= Hourly pipe heat loss with non-zero water flow (Btu/hr), see Equation 16

PLCD_n= Hourly pipe heat loss without water flow (Btu/hr), see Equation 21

n= Recirculation pipe section index, 1 through 6

APPENDIX B — Water Heating Calculation Method

$$\underline{PLWF_n = Flow_n \times (1 - f_{noflow,n}) \times \rho \times C_p \times (T_{n,in} - T_{n,out})}$$

Equation 16

Where

Flow_n = Flow_{recirc} + Flow_{n,draw} (gph), assuming

Flow_{n,draw} = Average hourly hot water draw flow (gph); for supply sections, n=1, 2, or 3, Flow_{n,draw} = GPH_k/NLoop_k; for return pipes, n=4, 5, and 6, Flow_{n,draw} = 0

Flow_{recirc} = Hourly recirculation flow (gph) is assumed to be 360 gallons based on the assumption that the recirculation flow rate is 6 gpm

f_{noflow,n} = Fraction of the hour for pipe section n to have zero water flow, see Equation 17

ρ = Density of water, 8.345 (lb/gal)

C_p = Specific heat of water, 1 (Btu/lb-°F)

T_{n,in} = Input temperature of section n (°F); for the first section (n=1), T_{1,in} shall be determined based on Table B-2. The control schedule of the proposed design shall be based on user input. The standard design is demand control. For other sections, input temperature is the same as the output temperature the proceeding pipe section, T_{n,in} = T_{n-1,out}

T_{n,out} = Output temperature of section n (°F), see Equation 18

$$\underline{f_{noflow,n} = (1 - SCH_{k,m}) \times NoDraw_n}$$

Equation 17

Where

NoDraw_n = Fraction of the hour that is assumed to have no hot water draw flow for pipe section n; NoDraw₁ = 0.2, NoDraw₂ = 0.4, NoDraw₃ = 0.6, NoDraw₄ = NoDraw₅ = NoDraw₆ = 1

SCH_{k,m} = Recirculation pump operation schedule, representing the fraction of the hour that the recirculation pump is turned off, see Table B-2 or Table B-3. SCH_{k,m} for the proposed design shall be based on proposed recirculation system controls. Recirculation system control for the standard design is demand control.

$$\underline{T_{out,n} = T_{amb,n} + (T_{in,n} - T_{amb,n}) \times e^{-\frac{UA_n}{\rho C_p Flow_n}}}$$

Equation 18

Where

T_{Amb,n} = Ambient temperature of section n (°F), which can be outside air, underground, conditioned, or semiconditioned air. Outside air temperatures shall be the dry-bulb temperature from the weather file. Underground temperatures shall be

APPENDIX B — Water Heating Calculation Method

obtained from Equation 11. Hourly conditioned air temperatures shall be the same as conditioned space temperature. For the proposed design, $T_{amb,n}$ options shall be based on user input. The standard design assumes all pipes are in conditioned air.

$UA_n =$ Heat loss rate of section n (Btu/hr-°F), see Equation 19

$$UA_n = Len_n \times \min(U_{bare,n}, f_{UA} \times U_{insul,n})$$

Equation 19

Where

$Len_n =$ Section n pipe length (ft); for the proposed design, use user input; for the standard design, see Equation 30

$U_{bare,n}, U_{insul,n} =$ Loss rates for bare (uninsulated) and insulated pipe (Btu/hr-ft-°F), evaluated using Equation 20 with section-specific values, as follows:

$Dia_n =$ Section n pipe nominal diameter (inch); for the proposed design, use user input; for the standard design, see Equation 31.

$Thick_n =$ Pipe insulation minimum thickness (inch) as defined in the Title 24 Section 120.3, TABLE 120.3-A for service hot water system

$Cond_n =$ Insulation conductivity shall be assumed = 0.26 (Btu inch/h-sf·F)

$h_n =$ Section n combined convective/radiant surface coefficient (Btu/hr-ft²-F) assumed = 1.5

$f_{UA} =$ Correction factor to reflect imperfect insulation, insulation material degradation over time, and additional heat transfer through connected branch pipes that is not reflected in branch loss calculation. It is assumed to be 2.0.

Equation 20 defines general relationships used to calculate heat loss rates for both loop and branches using appropriate parameters.

$$Dia_o = Dia + 0.125$$

$$U_{bare} = h \times \pi \times \frac{Dia_o}{12}$$

$$Dia_x = Dia_o + 2 \times Thick$$

$$U_{insul} = \frac{\pi}{\frac{\ln\left(\frac{Dia_x}{Dia_o}\right)}{\frac{2 \times Cond}{12}} + \frac{12}{h \times Dia_x}}$$

Equation 20

Where

$Dia =$ Pipe nominal size (in)

APPENDIX B — Water Heating Calculation Method

Dia_o = Pipe outside diameter (in)

Dia_x = Pipe + insulation outside diameter (in)

Thick = Pipe insulation thickness (in)

Cond = Insulation conductivity (Btu in/hr-ft²- °F)

h = Combined convective/radiant surface coefficient (Btu/hr-ft²- °F)

Pipe heat loss without water flow shall be calculated according to the following equations:

$$PLCD_n = Vol_n \times \rho \times C_p \times (T_{n,start} - T_{n,end}) \quad \text{Equation 21}$$

Where

Vol_n = Volume of section n (gal) is calculated as $7.48 \times \pi \times \left(\frac{Dia_o}{24}\right)^2 \times Len_n$ where 7.48 is the volumetric unit conversion factor from cubic feet to gallons. Note that the volume of the pipe wall is included to approximate the heat capacity of the pipe material.

T_{n,start} = Average pipe temperature (°F) of pipe section n at the beginning of the hour. It is the average of T_{n,in} and T_{n,out} calculated according to Equation 19 and associated procedures.

T_{n,end} = Average pipe temperature (°F) of pipe section n at the end of pipe cool down, see Equation 22

$$T_{n,end} = T_{amb,n} + (T_{n,start} - T_{amb,n}) \times e^{-\frac{UA_n \times f_{no\ flow,n}}{Vol_n \times \rho \times C_p}} \quad \text{Equation 22}$$

Equation 23 calculates average pipe temperature after cooling down, so the pipe heat loss calculated by Equation 22 is for pipe with zero flow for fraction $f_{no\ flow,n}$ of an hour. Recirculation pumps are usually turned off for less than an hour and there could be hot water draw flows in the pipe. As a result, recirculation pipes usually cool down for less than an hour. The factor $f_{no\ flow,n}$ calculated according to Equation 18 is used to reflect this effect in Equation 23.

Hourly Recirculation Branch Pipe Heat Loss Calculation

The proposed design and standard design shall use the same branch pipe heat loss assumptions. Branch pipe heat loss is made up of two components. First, pipe heat losses occur when hot water is in use (HBUL). Second, there could be losses associated with hot water waste (HBWL) when hot water was used to displace cold water in branch pipes and hot water is left in pipe to cool down after hot water draws and must be dumped down the drain.

The total hourly branch losses (HRBL_k) shall include both components and be calculated as:

APPENDIX B — Water Heating Calculation Method

$$HRBL_k = Nbranch_k \times (HBUL + HBWL) \quad \text{Equation 23}$$

Where

HBUL = Hourly pipe loss for one branch when water is in use (Btu/hr), see Equation 24

HBWL = Hourly pipe loss for one branch due to hot water waste (Btu/hr), see Equation 27

Nbranch_k = Number of branches in water heating system k, see Equation 32

The hourly branch pipe loss while water is flowing is calculated in the same way as recirculation pipe heat loss with nonzero water flow (PLWF) using the following equations:

$$HBUL = \left(\frac{GPH_k}{NBranch_k} \right) \times \rho \times C_p \times (T_{b,in} - T_{b,out}) \quad \text{Equation 24}$$

Where

T_{b,in} = Average branch input temperature (°F). It is assumed to be equal to the output temperature of the first recirculation loop section, T_{1,out}

T_{b,out} = Average branch output temperature (°F), see Equation 25

$$T_{b,out} = T_{amb,b} + (T_{b,in} - T_{amb,b}) \times e^{-\frac{UA_b}{\rho \times C_p \times Flow_b}} \quad \text{Equation 25}$$

Where

T_{amb,b} = Branch pipe ambient temperature (°F). Branch pipes are assumed to be located in the conditioned or semiconditioned air.

UA_b = Branch pipe heat loss rate (Btu/hr-°F), see Equation 26

Flow_b = Branch hot water flow rate during use (gal/hr). It is assumed to be 2 gpm or 120 gal/hr.

The branch pipe heat loss rate is

$$UA_b = Len_b \times U_{insul,b} \quad \text{Equation 26}$$

Where

Len_b = Branch pipe length (ft), see Equation 34

U_{insul,b} = Loss rate for insulated pipe (Btu/hr-ft-°F), evaluated using Equation 21 with branch-specific values, as follows:

Dia_b = Branch pipe diameter (inch), see Equation 33

Thick_b = Branch pipe insulation minimum thickness (inch) as defined in the Title 24 Section 120.3, TABLE 120.3-A for service hot water system.

APPENDIX B — Water Heating Calculation Method

- $Cond_b$ = Branch insulation conductivity, assumed = 0.26 Btu in/hr-ft²- °F
 h_b = Branch combined convective/radiant surface coefficient (Btu/hr-ft²- °F) assumed = 1.5

The hourly pipe loss for one branch due to hot water waste is calculated as follows:

HBWL =

$$N_{waste} \times SCH_{waste,m} \times f_{vol} \times 7.48 \times \pi \times \left(\frac{Dia_b + 0.125}{24} \right)^2 \times Len_b \times \rho \times C_p \times (T_{b,in} - T_{inlet})$$

Equation 27

Where

N_{waste} = Number of times in a day for which water is dumped before use. This number depends on the number of dwelling units served by a branch. Statistically, the number of times of hot water waste is wasted is inversely proportional to the number of units a branch serves, see Equation 28.

$SCH_{waste,m}$ = Hourly schedule of water waste, see Table B-5

f_{vol} = The volume of hot water waste is more than just the volume of branch pipes, due to branch pipe heating, imperfect mixing, and user behaviors. This multiplier is applied to include these effects and is assumed to be 1.4.

$T_{in,b}$ = Average branch input temperature (°F) is assumed to equal the output temperature of the first recirculation loop section, $T_{OUT,1}$

T_{inlet} = The cold water inlet temperature (°F) according to Section 3.3 Cold Water Inlet Temperature

$$N_{waste} = 19.84 \times e^{-0.544 \times N_{unit_b}}$$

Equation 28

Method WH-
BRWF

Where

N_{unit_b} = Number of dwelling units served by the branch, calculated using Equation 29 (N_{unit_b} is not necessarily integral).

$$N_{unit_b} = \frac{N_{floor}}{2}$$

Method WH-BRNU

Equation 29

Table B-5: Branch Water Waste Schedule

| Hour | SCH _{waste,m} |
|------|------------------------|
| 1 | 0.01 |
| 2 | 0.02 |
| 3 | 0.05 |
| 4 | 0.22 |
| 5 | 0.25 |
| 6 | 0.22 |
| 7 | 0.06 |
| 8 | 0.01 |
| 9 | 0.01 |
| 10 | 0.01 |
| 11 | 0.01 |
| 12 | 0.01 |
| 13 | 0.01 |
| 14 | 0.01 |
| 15 | 0.01 |
| 16 | 0.01 |
| 17 | 0.01 |
| 18 | 0.01 |
| 19 | 0.01 |
| 20 | 0.01 |
| 21 | 0.01 |
| 22 | 0.01 |
| 23 | 0.01 |
| 24 | 0.01 |

Source: California Energy Commission

Recirculation System Plumbing Designs

A recirculation system can have one or several recirculation loops. Each recirculation loop consists of many pipe sections, which are connected in sequence to form a loop. Each pipe section could have different pipe diameter, length, and location. The compliance software shall use six pipe sections, with three supply pipe sections and three return pipe sections, to represent a recirculation loop. When multiple recirculation loops exist, all recirculation loops are assumed identical. The compliance software shall provide default and standard recirculation system designs based on building geometry according to the procedures described in the following sections. The default design reflects typical recirculation loop

APPENDIX B — Water Heating Calculation Method

design practices. The standards design is based on one or two loops and is used to set recirculation loop heat loss budget.

The first step of establishing recirculation system designs is determining the number of recirculation loops, N_{loop_k} , in water heating system k . The standard design has one recirculation loop, $N_{loop_k} = 1$, when $N_{unit} \leq 8$, or two recirculation loops, $N_{loop_k} = 2$ for buildings with $N_{unit} > 8$. The proposed design is allowed to specify more than one loop only if the design is verified by a HERS Rater. Otherwise, the proposed design can only be specified to have one recirculation loop.

The standard and default recirculation loop designs are based on characteristics of the proposed building. There could be many possibilities of building shapes and dwelling unit configurations, which would determine recirculation loop pipe routings. Without requiring users to provide detailed dwelling unit configuration information, the compliance software shall assume the proposed buildings to have same dwelling units on each floor and each floor to have a corridor with dwelling units on both sides. Recirculation loops start from the mechanical room (located on the top floor), go vertically down to the middle floor, loop horizontally in the corridor ceiling to reach the dwelling units on both ends of the building, then go vertically up back to the mechanical room. At each dwelling unit on the middle floor, vertical branch pipes, connected to the recirculation loop supply pipe, are used to provide hot water connection to dwelling units on other floors above and below.

Both the standard and default recirculation loop designs are assumed to have equal length of supply sections and return sections. The first section is from the mechanical room to the middle floor. The second section serves first-half branches connected to the loop, and the third section serves the rest of the branches. The first and second sections have the same pipe diameter. Pipe size for the third section is reduced since fewer dwelling units are served. Return sections match with the corresponding supply pipes in pipe length and location. All return sections have the same diameter. For the standard and default designs, mechanical room is optimally located so that only vertical piping is needed between the mechanical room and the recirculation pipes located on the middle floor. Pipe sizes are determined based on the number of dwelling units served by the loop, following the 2009 Uniform Plumbing Code (UPC) pipe sizing guidelines. The detailed recirculation loop configurations are calculated as follows:

Pipe length in the mechanical room (ft): $L_{mech} = 8$

Height of each floor (ft): $H_{floor} = \text{user input floor-to-floor height (ft)}$

Length of each dwelling unit (ft): $L_{unit} = \sqrt{CFAU_k}$ (see Equation 7)

Length of recirculation pipe sections (ft):

$$Len_1 = Len_6 = L_{mech} + H_{floor} \times \frac{N_{floor}}{2}$$

APPENDIX B — Water Heating Calculation Method

$$Len_2 = Len_3 = Len_4 = Len_5 = L_{unit} \times \frac{N_{unit_k}}{4 \times N_{loop_k} \times N_{floor}} \quad \text{Equation 30}$$

Method WH-LOOPLEN

Pipe diameters for recirculation loop supply sections depend on the number of dwelling units being served and return section diameters depend only on building type, as follows:

Dia₁, Dia₂, and Dia₃: derived from Table B-6 based on Nunit₁, Nunit₂, and Nunit₃

Dia₄ = Dia₅ = Dia₆ = 0.75 in for low-rise multifamily building and hotel/motel less than four stories

Dia₄ = Dia₅ = Dia₆ = 1.0 in for high-rise multifamily and hotel/motel more than three stories
Equation 31

Method WH-LOOPSZ

Where

$$N_{unit_1} = \text{Number of dwelling units served by the loop section 1} = \frac{N_{unit_k}}{N_{loop_k}}$$

$$N_{unit_2} = N_{unit_1}$$

$$N_{unit_3} = \frac{N_{unit_1}}{2}$$

Nunit values are not necessarily integers.

Branch pipe parameters include number of branches, branch length, and branch diameter. The number of branches in water heating system k is calculated as (note: not necessarily an integer):

$$N_{branch_k} = \frac{N_{unit_k}}{N_{unit_b}} \quad \text{Equation 32}$$

Method WH-BRN

The branch pipe diameter shall be determined as follows:

$$\text{Dia}_b: \text{ derived from Table B-6 based on } N_{unit_b} \quad \text{Equation 33}$$

Method WH-BRSZ

The branch length includes the vertical rise based on the number of floors in the building plus four feet of pipe to connect the branch to the recirculation loop.

$$Len_b = 4 + H_{floor} \times N_{floor} / 2 \quad \text{Equation 34}$$

Method WH-BRLEN

Proposed designs shall use the same branch configurations as those in the standard design. Therefore, compliance software does not need to collect branch design information.

Table B-6: Pipe Size Schedule

| Number of dwelling units served NUnit_n or NUnit_b | Loop pipe nominal size Dia_n in | Branch pipe nominal size Dia_b in |
|---|--|--|
| < 2 | 1.5 | 1 |
| 2 ≤ N < 8 | 1.5 | 1.5 |
| 8 ≤ N < 21 | 2 | 2 |
| 21 ≤ N < 42 | 2.5 | 2.5 |
| 42 ≤ N < 68 | 3 | 3 |
| 68 ≤ N < 101 | 3.5 | 3.5 |
| 101 ≤ N < 145 | 4 | 4 |
| 145 ≤ N < 198 | 5 | 5 |
| N ≥ 198 | 6 | 6 |

Source: California Energy Commission

B6. High-Rise Residential Buildings, Hotels and Motels

Simulations for high-rise residential buildings, hotels, and motels shall follow all the rules for central or individual water heating with the following exceptions:

- For central systems that do not use recirculation but use electric trace heaters, the program shall assume equivalency between the recirculation system and the electric trace heaters.
- For individual water heater systems that use electric trace heating instead of gas, the program shall assume equivalency.

B7. Energy Use of Individual Water Heaters

Once the hourly adjusted recovery load is determined for each water heater, the energy use for each water heater is calculated as described below and summed.

Consumer or Residential-Duty Commercial Storage Water Heaters

Storage water heaters are rated either by EF (energy factor) or the newer UEF (Uniform Energy Factor). The calculation algorithm for these devices derives a Load Dependent

APPENDIX B — Water Heating Calculation Method

Energy Factor (LDEF) from EF. For water heaters rated with UEF, CBECC-Res calculates an equivalent EF.

The hourly energy use of storage gas water heaters is given by the following equation.

$$WHEU_j = \frac{HARL_j \times HPAF_j}{LDEF_j} \quad \text{Equation 35}$$

Where

WHEU_j = Hourly energy use of the water heater (Btu for fuel or kWh for electric); Equation 36 provides a value in units of Btu. For electric water heaters, the calculation result needs to be converted to the unit of kWh by dividing 3413 Btu/kWh.

HARL_j = Hourly adjusted recovery load (Btu)

HPAF_j = 1 for all non-heat-pump water heaters

LDEF_j = The hourly Load Dependent Energy Factor (LDEF) is given by

$$LDEF_j = \min \left[LDEF_{\max} \left(LDEF \ln \left(\frac{AAHARL_j \times 24}{1000} \right) (a \times EF_j + b)(c \times EF_j + d) \right) \right]_{\min} \left(0 \right)_{\max}$$

Equation 36. This equation adjusts the nominal EF rating for storage water heaters for different load conditions.

$$LDEF_j = \min \left[LDEF_{\max} \left(LDEF \ln \left(\frac{AAHARL_j \times 24}{1000} \right) (a \times EF_j + b)(c \times EF_j + d) \right) \right]_{\min} \left(0 \right)_{\max} \quad \text{Equation 36}$$

Where

a,b,c,d = Coefficients from the table below based on the water heater type

Table B-7: LDEF Coefficients

| Coefficient | Storage Gas |
|---------------------|-------------|
| A | -0.098311 |
| B | 0.240182 |
| C | 1.356491 |
| D | -0.872446 |
| LDEF _{min} | .1 |
| LDEF _{max} | .90 |

Source: California Energy Commission

AAHARL_j = Annual average hourly adjusted load (Btu) = $\frac{1}{8760} \sum_{1}^{8760} HARL_j$; calculation of AAHARL_j requires a preliminary annual simulation that sums HARL_j values for each hour.

APPENDIX B — Water Heating Calculation Method

EF_j = Energy factor of the water heater (unitless). This is based on the DOE test procedure. EF for storage gas water heaters with volume less than 20 gallons must be assumed to be 0.58 unless the manufacturer has voluntarily reported an actual EF to the California Energy Commission.

CBECC-Res derives EF_j from UEF for water heaters that are rated using updated DOE procedures.

Consumer and Residential-Duty Commercial Water Heaters

UEF-rated consumer and residential-duty commercial instantaneous water heaters (gas and electric) are modeled on a minute-by-minute basis using procedures documented by Lutz (2019).

Small Instantaneous Gas Water Heaters

The hourly energy use for instantaneous gas or oil water heaters is given by Equation 37, where the nominal rating is multiplied by 0.92 to reflect the effects of heat exchanger cycling under real-world load patterns.

$$WHEU_j = \frac{HARL_j}{EF_j \times 0.92} \quad \text{Equation 37}$$

Where

$WHEU_j$ = Hourly fuel energy use of the water heater (Btu)

$HARL_j$ = Hourly adjusted recovery load

EF_j = Energy factor from the DOE test procedure (unitless) taken from manufacturers' literature or from the CEC Appliance Database

0.92 = Efficiency adjustment factor

Small Instantaneous Electric Water Heaters

The hourly energy use for consumer instantaneous electric water heaters is given by the following equation.

$$WHEU_{j,elec} = \frac{HARL_j}{EF_j \cdot 0.92 \cdot 3413} \quad \text{Equation 38}$$

Where

$WHEU_{j,elec}$ = Hourly electric energy use of the water heater (kWh)

$HARL_j$ = Hourly adjusted recovery load (Btu)

EF_j = Energy factor from DOE test procedure (unitless)

0.92 = Adjustment factor to adjust for overall performance

3413 = Unit conversion factor (Btu/kWh)

Mini-Tank Electric Water Heater

Mini-tank electric heaters are occasionally used with gas tankless water heaters to mitigate hot water delivery problems related to temperature fluctuations that may occur between draws. If mini-tank electric heaters are installed, the installed units must be listed in the CEC Appliance Database and their reported standby loss (in Watts) will be modeled to occur each hour of the year. (If the unit is not listed in the CEC Appliance Database, a standby power consumption of 35 W should be assumed.)

$$WHEU_{j,elec} = MTSBL_j/1000 \quad \text{Equation 39}$$

Where

$WHEU_{j,elec}$ = Hourly standby electrical energy use of mini-tank electric water heaters (kWh)

$MTSBL_j$ = Mini-tank standby power (W) for tank j (if not listed in CEC Appliance directory, assume 35 W)

Large/Commercial Gas Storage Water Heaters

Energy use for large storage gas is determined by the following equations. Large storage gas water heaters are defined as any gas storage water heater with a minimum input rate of 75,000 Btu/h.

$$WHEU_j = \frac{HARL_j}{EFF_j} + SBL_j \quad \text{Equation 40}$$

Where

$WHEU_j$ = Hourly fuel energy use of the water heater (Btu)

$HARL_j$ = Hourly adjusted recovery load (Btu)

SBL_j = Total standby loss (Btu/hr). Obtain from CEC Appliance Database or from AHRI certification database. This value includes tank losses and pilot energy. If standby rating is not available from either of the two databases, it shall be calculated as per Table F-2 of the 2015 Appliance Efficiency Regulations, as follows:

$SBL = Q/800 + 110 (V)^{1/2}$, where Q is the input rating in Btu/hour, and V is the tank volume in gallons.

EFF_j = Efficiency (fraction, not %). Obtained from CEC Appliance Database or from manufacturer's literature. These products may be rated as a recovery efficiency, thermal efficiency or AFUE.

Large/Commercial Instantaneous, Indirect Gas, and Hot Water Supply Boilers

Energy use for these types of water heaters is given as follows:

APPENDIX B — Water Heating Calculation Method

$$WHEU_j = \frac{HARL_j}{EFF_j \times 0.92} + PILOT_j \quad \text{Equation 41}$$

Where

- WHEU_j = Hourly fuel energy use of the water heater (Btu), adjusted for tank insulation.
- HARL_j = Hourly adjusted recovery load. For independent hot water storage tank(s) substitute HARL_j from Section B3.
- EFF_j = Efficiency (fraction, not %) to be taken from CEC Appliance Database or from manufacturers literature. These products may be rated as a recovery efficiency, thermal efficiency or AFUE.
- PILOT_j = Pilot light energy (Btu/h) for large instantaneous. For large instantaneous water heaters, and hot water supply boilers with efficiency less than 89 percent assume the default is 750 Btu/hr if no information is provided in manufacturer's literature or CEC Appliance Database.
- 0.92 = Adjustment factor used when system is not supplying a storage system.

Consumer Storage Electric or Heat Pump Water Heaters

Energy use for small electric water heaters is calculated as described in the HPWHsim Project Report (Ecotope, 2016) and in documents specified in Section B6. (See also study by NEEA referenced in Appendix F.) The HPWH model uses a detailed, physically based, multinode model that operates on a one-minute time step implemented using a suitable loop at the time-step level within CSE. Tank heat losses and heat pump source temperatures are linked to the CSE zone heat balance as appropriate. Thus, for example, the modeled air temperature of a garage containing a heat pump water heater will reflect the heat extracted.

HPWHsim can model three classes of equipment:

- Specific air-source heat pump water heaters identified by manufacturer and model. These units have been tested by Ecotope, and measured parameters are built into the HPWH code.
- Generic air-source heat pump water heaters, characterized by EF and tank volume. This approach provides compliance flexibility. The performance characteristics of the generic model are tuned to use somewhat more energy than any specific unit across a realistic range of UEF values.
- Electric resistance water heaters, characterized by EF, tank volume, and resistance element power.

Several issues arise from integration of a detailed, short time-step model into an hourly framework. HPWH is driven by water draw quantities, not energy requirements. Thus, to

APPENDIX B — Water Heating Calculation Method

approximate central system distribution and unfired tank losses, fictitious draws are added to the scheduled water uses, as follows:

$$V_{j,t} = \frac{VS_{k,t} + \frac{HRDL_k + \sum_1^{NL_k} HJL_l}{60 \times 8.345 \times (t_s - t_{inlet})}}{NWH_k}$$

Equation 42

Where

- HRDL_k = Hourly recirculation distribution loss (Btu), see Equation 15; HRDL_k is nonzero only for multifamily central water heating systems
- HJL_l = Tank surface losses of the lth unfired tank of the kth system (Btu), see Equation 43
- VS_k = Hot water draw at the kth water heating system's delivery point (gal)
- V_{j,t} = Hot water draw (gal) on jth water heater for minute t

Another issue is that the HPWH hot water output temperature varies based on factors such as control hysteresis and tank mixing. For compliance applications, it is required that all system alternatives deliver the same energy. To address this, the HPWH tank setup point is modeled at 125°F, and delivered water is tempered to t_s . If the HPWH output temperature is above t_s , it is assumed that inlet water is mixed with it (thus reducing $V_{i,t}$). If the output temperature is below t_s , sufficient electrical resistance heating is supplied to bring the temperature up to t_s (preventing undersizing from being exploited as a compliance advantage).

Jacket Loss

The hourly jacket loss for the lth unfired tank or indirectly fired storage tank in the kth system is calculated as:

$$HJL_l = \frac{TSA_l \times \Delta TS}{RT_{l1} + REI_l} + FTL_l$$

Equation 43

Where

- HJL_l = The tank surface losses of the lth unfired tank of the kth system
- TSA_l = Tank surface area (ft²), see Equation 44
- ΔTS = Temperature difference between ambient surrounding tank and hot water supply temperature (°F). Hot water supply temperature shall be 124°F. For tanks located inside conditioned space use 75°F for the ambient temperature. For tanks in outside conditions, use hourly dry bulb temperature ambient.
- FTL_l = Fitting losses; a constant 61.4 Btu/h
- REI_l = R-value of exterior insulating wrap; no less than R-12 is required

APPENDIX B — Water Heating Calculation Method

RTI_i = R-value of insulation internal to water heater; assume 0 without documentation

Tank surface area (TSA) is used to calculate the hourly jacket loss (HJL) for unfired or indirectly fired tanks. TSA is given in the following equation as a function of the tank volume.

$$TSA_i = (1.254 \times VOL_i^{0.33} + .531)^2 \quad \text{Equation 44}$$

Where

VOL_i = Tank capacity (gal)

Electricity Use for Circulation Pumping

For single-family recirculation systems, hourly pumping energy is fixed as shown in Table B-8.

Multifamily recirculation systems typically have larger pump sizes, and, therefore, electrical energy use is calculated based on the installed pump size. The hourly recirculation pump electricity use (HEUP) is calculated by the hourly pumping schedule and the power of the pump motor as in the following equation.

$$HEUP_k = \frac{0.746 \times PUMP_k \times SCH_{k,m}}{\eta_k} \quad \text{Equation 45}$$

Where

$HEUP_k$ = Hourly electricity use for the circulation pump (kWh)

$PUMP_k$ = Pump brake horsepower (bhp)

η_k = Pump motor efficiency

$SCH_{k,m}$ = Operating schedule of the circulation pump. (See Table B-3.) The operating schedule for the proposed design shall be based on user input control method. The standard design operation schedule is demand control.

Table B-8: Single-Family Recirculation Energy Use (kWh) by Hour of Day

| Hour | Non-Demand-Controlled Recirculation | Demand-Controlled Recirculation |
|---------------------|--|--|
| 1 | 0.040 | 0.0010 |
| 2 | 0.040 | 0.0005 |
| 3 | 0.040 | 0.0006 |
| 4 | 0.040 | 0.0006 |
| 5 | 0.040 | 0.0012 |
| 6 | 0.040 | 0.0024 |
| 7 | 0.040 | 0.0045 |
| 8 | 0.040 | 0.0057 |
| 9 | 0.040 | 0.0054 |
| 10 | 0.040 | 0.0045 |
| 11 | 0.040 | 0.0037 |
| 12 | 0.040 | 0.0028 |
| 13 | 0.040 | 0.0025 |
| 14 | 0.040 | 0.0023 |
| 15 | 0.040 | 0.0021 |
| 16 | 0.040 | 0.0019 |
| 17 | 0.040 | 0.0028 |
| 18 | 0.040 | 0.0032 |
| 19 | 0.040 | 0.0033 |
| 20 | 0.040 | 0.0031 |
| 21 | 0.040 | 0.0027 |
| 22 | 0.040 | 0.0025 |
| 23 | 0.040 | 0.0023 |
| 24 | 0.040 | 0.0015 |
| Annual Total | 350 | 23 |

Source: California Energy Commission

B8. Energy Use of Central Heat Pump Water Heater Systems

Energy use for central heat pump water heater (CHPWH) systems is calculated by HPWHsim in a way similar to consumer electric heat pump water heaters. The HPWH model uses a detailed, physically based, multinode model that operates on a 1-minute time step. This model is implemented using a suitable loop at the time-step level within CSE. Unlike with consumer electric HPWH, the central HPWH systems are built from several components selected by the building designer. The energy performance of central water heating systems is determined by these components: the primary heating equipment, primary heating storage volume, location, secondary heating equipment, secondary heating storage volume, set point controls, and the way in which the components are plumbed.

APPENDIX B — Water Heating Calculation Method

To calculate the energy use, CBECC uses information regarding the characteristics of the central HPWH system defined in the following tables and lists.

Table B-9: DHW Central/Recirculation Type

| Name | DHW System Description |
|----------------------------|---|
| Non-Central | A system with a water heater for each dwelling unit. |
| Central, no Recirculation | A DHW system with equipment providing hot water for all dwelling units in the building. No hot water temperature maintenance recirculation loop is used. |
| Central with Recirculation | A DHW system with equipment providing hot water for all dwelling units in the building. Hot water temperature maintenance recirculation loop is used. Plumbing of recirculation loop in relation to central heating equipment is specified. |

Source: California Energy Commission

Table B-10: Central HPWH Primary System Type

| Name | HPWH Description |
|----------------------------|---|
| Single-Pass Primary | A split-system HPWH that regulates flow such that it heats cold water to setpoint in a single trip through the heating equipment. |
| Multi-Pass Primary | A split-system HPWH with constant flow that incrementally heats water through multiple trips through the heating equipment. |
| Integrated/Packaged System | A HPWH that contains the heat pump components and storage tank in one device. These may also contain one or two electric resistance heating elements. |

Source: California Energy Commission

For single-pass primary/multi-pass primary either primary or secondary types:

- **HPWH/Compressor Model** — The manufacturer and model number of the HPWH, with heating capacity provided 40°F ambient air.

APPENDIX B — Water Heating Calculation Method

- **Compressor/Heater Count** — Number of single-pass primary or multi-pass compressors, either primary or secondary.
- **Total Tank Volume** — Total storage volume of all tanks, either primary or secondary.
- **Tank Count** — The number of storage tanks that the total tank volume is distributed over, either primary or secondary.
- **Tank R-Value** — The R-Value of the insulation around the storage tanks, either primary or secondary.

Table B-11 applies to integrated/package system, either primary or secondary types.

Table B-11: Integrated/Package Type

| Name | Integrated/Package Type Description |
|----------------------------------|--|
| Residential (NEEA rated) Product | An integrated/package HPWH listed in NEEA’s Residential Unitary Qualified Products List. |
| Commercial Product | An integrated/package HPWH of storage volume greater than or equal to 120 gallons or heating capacity greater than 6 kW. |

Source: California Energy Commission

For residential (NEEA-rated) product:

- **NEEA HPWH Brand/Model** — The manufacturer and model number of the HPWH, provided with the nominal storage capacity, for either the primary or secondary type.
- **NEEA HPWH Count** — An integer number of residential (NEEA-rated) integrated/package HPWHs, this includes the storage tank and the heating elements.

For commercial product:

- **Commercial HPWH Product** — The manufacturer and model number of the HPWH, provided with the nominal storage capacity, for either the primary or secondary type.
- **HPWH Count** — An integer number of commercial integrated/package HPWHs, this includes the storage tank and the heating elements.

For all HPWH types as either primary or secondary:

- **Tank Location** — The location of the storage tanks, either outside or a specific zone, for the primary or secondary tank.
- **Source Air From** — The location that the HPWH draws air from, either outside or a specific zone. For a split-system single-pass or multi-pass HPWH the HPWH may be

APPENDIX B — Water Heating Calculation Method

located in a separate location than the tank location, or for an integrated/packaged type, the source air can be ducted from a separate location.

Table B-12: Secondary Tank Configuration

| Name | Secondary Tank Configuration Description |
|--------------------------|--|
| None (Return to Primary) | No secondary or loop tank for the recirculation loop to return to. The recirculation loop is returned to the bottom of the primary tank. |
| Series (Swing) | A tank where the outlet of the primary tank is piped to the bottom of the secondary tank, to mix the secondary tank through thermal buoyancy effects. The recirculation loop is piped to the bottom of the secondary tank. |
| Parallel | A tank where the outlet of the primary tank is piped to the top of the secondary tank, to maintain thermal stratification in the secondary tank. The recirculation loop is piped to the bottom of the secondary tank. |

Source: California Energy Commission

The secondary tank type is largely the same as the primary system type but includes the option for an electric resistance heater.

Table B-13: Secondary Tank Type

| Name | Secondary Tank Type Description |
|----------------------------|---|
| Electric Resistance | An electric resistance water heater with two resistance elements. The total heating capacity is 350 W per apartment unit in the building, and it has a set point of 136°F to supply a minimum of 125°F water with a 10° F deadband. |
| Integrated/Packaged System | A HPWH that contains the heat pump components and storage tank in one device. These also contain one or two electric resistance heating elements. |
| Single Pass Primary | A split-system HPWH that regulates flow such that it heats cold water to set point in a single trip through the heating equipment. |

APPENDIX B — Water Heating Calculation Method

| | |
|--------------------|---|
| Multi Pass Primary | A split-system HPWH with constant flow that incrementally heats water through multiple trips through the heating equipment. |
|--------------------|---|

Source: California Energy Commission

In CHPWH systems, there is always a primary system type and, optionally, a secondary system type. The primary system heats incoming cold water to the primary tank setpoint. If a recirculation loop is present, the primary system may be configured to heat return water from the recirculation loop. In that case, the recirculation loop is returned to the bottom of the primary tank storage volume. Alternatively, a secondary heating system may be used. In which case, the recirculation loop is returned to the secondary tank.

CBECC is designed to simulate all the following CHPWH system alternatives. The temperature set points are fixed within the simulation based on the HPWH type and application:

- Single-pass primary (not CO₂ refrigerant): 140°F
- Single-pass primary (CO₂ refrigerant): 149°F
- Multi-pass primary: 140°F
- Integrated/packaged primary: 135°F
- Secondary (not CO₂ refrigerant): 136°F
- Secondary (CO₂ refrigerant): 149°F

Like consumer HPWH, hot water output temperature varies based on factors such as control hysteresis and tank mixing. For compliance applications, it is required that all system alternatives deliver the same energy. To address this, the HPWH tank setup point is modeled above the delivered water temperature, which is tempered to 125°F (t_s) with a thermostatic mixing valve. If the HPWH output temperature is above t_s , it is assumed that inlet water is mixed with it (thus reducing $V_{i,t}$). If the output temperature is below t_s , sufficient electrical resistance heating is supplied to bring the temperature up to t_s (preventing under sizing from being exploited as a compliance advantage).

The particular components, piping configuration, control, and system sizing possibilities are described in the subsequent sections for each hot water configuration.

Multi-Pass Integrated HPWH System Without Hot Water Circulation

Narrative: This schematic is applicable for use with integrated HPWH equipment. One or more integrated HPWHs may be specified. When multiple HPWHs are specified, they are piped in parallel. A thermostatic mixing valve is provided to temper the hot water supplied to the building hot water distribution system. There is no hot water circulation system present in this system configuration.

Figure 5: Multi-Pass Integrated HPWH System Without Hot Water Circulation

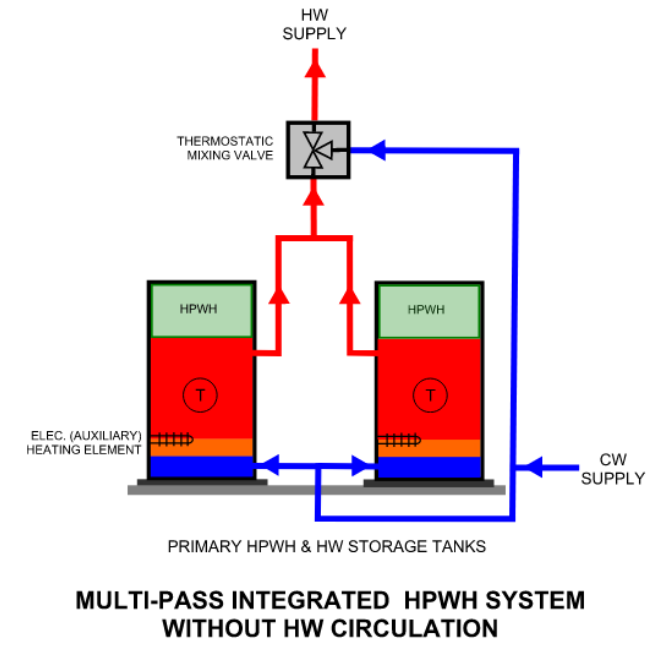

Source: California Energy Commission

Piping Configuration: Cold water is supplied to the lower portion of the integrated HPWH equipment. Outgoing hot water is connected to the upper portion of the integrated HPWH equipment. When multiple integrated HPWHs are specified, the incoming cold water supply to the HPWH equipment and outgoing hot water supply from the HPWH equipment are split and configured to supply equal flow to all integrated HPWH units. The outgoing hot water from the integrated HPWH(s) is connected to the hot supply side of the mixing valve. A cold water connection is provided to the cold supply side of the mixing valve. The tempered side of the mixing valve is connected to the building hot water distribution piping system.

Control: The integrated HPWH equipment is controlled by the internal equipment control system to prioritize compressor heating energy use and minimize auxiliary electric resistance heating energy use.

System Sizing: The integrated HPWH equipment is sized to meet the domestic hot water load. Several integrated HPWHs are specified when a single integrated HPWH equipment cannot meet the load.

Single-Pass Primary HPWH System Without Hot Water Circulation

Narrative: This schematic is applicable for use with single-pass HPWH equipment. One or more heat pumps (compressors) may be specified. When multiple HPWHs are specified, they are piped in parallel. A thermostatic mixing valve is provided to temper the hot water supplied to the building hot water distribution system. There is no hot water circulation system present in this system configuration.

Figure 6: Single-Pass Primary HPWH System Without Hot Water Circulation

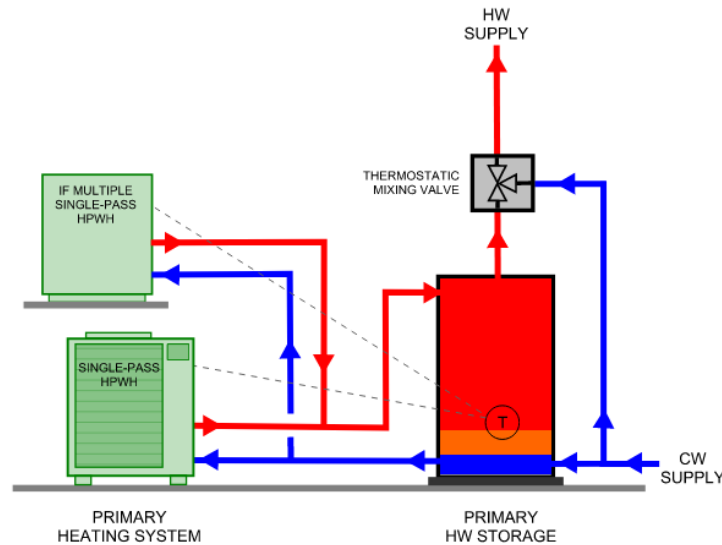

SINGLE-PASS PRIMARY HPWH SYSTEM WITHOUT HOT WATER CIRCULATION

Source: California Energy Commission

Piping Configuration: Cold water is supplied to the lower portion of the storage tank. Outgoing hot water is connected to the upper portion of the storage tank. The single-pass split system HPWH(s) is connected to draw water from the lower portion of the tank, heat this water to temperature, and supply to the upper portion of the storage tank. When multiple storage tanks are specified, the storage tanks are configured in series with the top of the first tank connected to the bottom of the second tank. This top-to-bottom connection is repeated for all storage tanks in series. The cold water is supplied to the lower portion of the first tank, and the outgoing hot water is supplied from the upper portion of the last storage tank in series. The outgoing hot water from the storage tank (or last storage tank in series) is connected to the hot supply side of the mixing valve. A cold water connection is provided to the cold supply side of the mixing valve. The outgoing tempered side of the mixing valve is connected to the building hot water distribution piping system.

Control: The single-pass split system HPWH(s) are controlled by a temperature sensor or multiple temperature sensors in the primary storage tank(s). Multiple parallel HPWHs are controlled in a single stage.

System Sizing: The HPWH equipment is sized to meet the domestic hot water load. Multiple HPWHs are specified when a single HPWH cannot meet the load.

Single-Pass Primary HPWH System with Secondary Electric Resistance Trim Heater Tank and Without Hot Water Circulation

Narrative: This schematic is applicable for use with single-pass HPWH equipment in combination with a secondary electric resistance trim tank. One or more heat pumps

APPENDIX B — Water Heating Calculation Method

(compressors) may be specified. When multiple HPWHs are specified, they are piped in parallel. A thermostatic mixing valve is provided to temper the hot water supplied to the building hot water distribution system. There is no hot water circulation system present in this system configuration.

Figure 7: Single-Pass Primary HPWH with Trim Tank

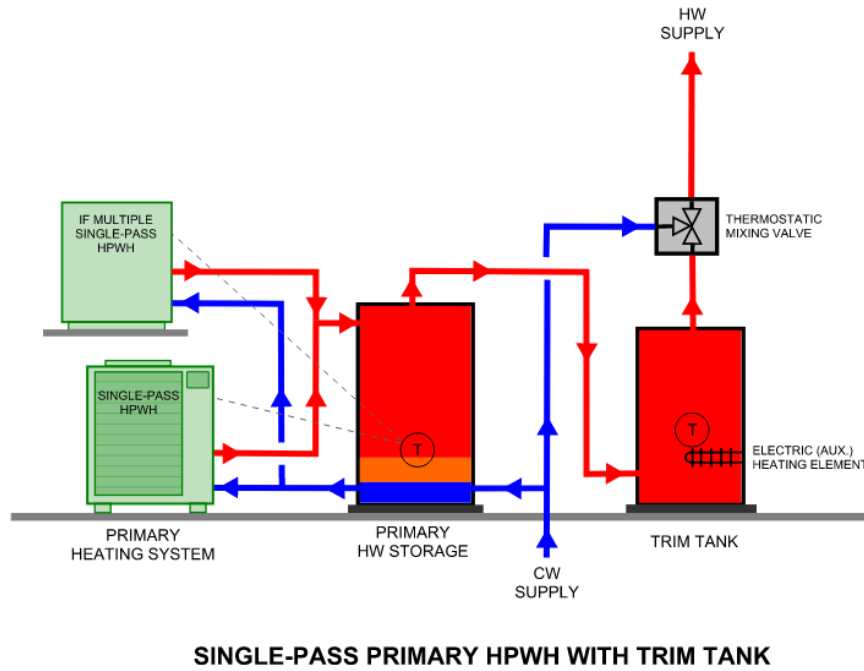

Source: California Energy Commission

Piping Configuration: Cold water is supplied to the lower portion of the storage tank. Outgoing hot water is connected to the upper portion of the storage tank and passes through a secondary electric resistance trim tank. The single-pass split system HPWH(s) is connected to draw water from the lower portion of the tank, heat this water to temperature, and supply it to the upper portion of the storage tank. When multiple storage tanks are specified, the storage tanks are configured in series with the top of the first tank connected to the bottom of the second tank. This top-to-bottom connection is repeated for all storage tanks in series. The cold water is supplied to the lower portion of the first tank, and the outgoing hot water is supplied from the upper portion of the last storage tank in series. The outgoing hot water from the storage tank (or last storage tank in series) is connected to a secondary electric resistance water heater piped in series. The outgoing hot water connection from the secondary electric resistance heater is connected to the hot supply side of the mixing valve. A cold water connection is provided to the cold supply side of the mixing valve. The outgoing tempered side of the mixing valve is connected to the building hot water distribution piping system.

Control: The single-pass split system HPWH(s) is controlled by a temperature sensor or multiple temperature sensors in the primary storage tank(s). Multiple parallel HPWHs are controlled in a single stage.

System Sizing: The HPWH equipment is sized to meet the domestic hot water load. Multiple HPWHs are specified when a single HPWH cannot meet the load. A secondary electric resistance tank is provided for backup or redundancy and sized to meet the domestic hot water load.

Multi-Pass Primary HPWH System Without Hot Water Circulation

Narrative: This schematic is applicable for use with multi-pass HPWH equipment. One or more heat pumps (compressors) may be specified. When multiple HPWHs are specified, they are piped in parallel. A thermostatic mixing valve is provided to temper the hot water supplied to the building hot water distribution system. There is no hot water circulation system present in this system configuration.

Figure 8: Multi-Pass Primary HPWH System Without Hot Water Circulation

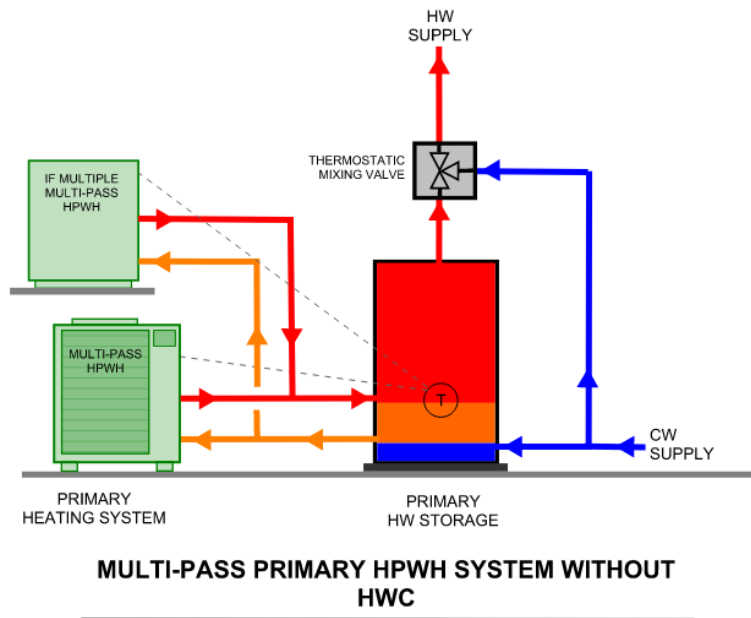

Source: California Energy Commission

Piping Configuration: Cold water is supplied to the lower portion of the storage tank. Outgoing hot water is connected to the upper portion of the storage tank. The multi-pass split system HPWH(s) is connected to draw water from the lower portion of the tank, heat this water approximately 10°F, and supply it to the middle portion of the storage tank. When multiple storage tanks are specified, the storage tanks are configured in parallel with equal flow through all parallel storage tanks. The outgoing hot water from the storage tank(s) is connected to the hot supply side of the mixing valve. A cold water connection is

APPENDIX B — Water Heating Calculation Method

provided to the cold supply side of the mixing valve. The outgoing tempered side of the mixing valve is connected to the building hot water distribution piping system.

Control: The multi-pass split system HPWH(s) is controlled by a temperature sensor or multiple temperature sensors in the primary storage tank(s). Multiple parallel HPWHs are controlled in a single stage.

System Sizing: The HPWH equipment is sized to meet the domestic hot water load. Multiple HPWHs are specified when a single HPWH equipment cannot meet the load.

Multi-Pass Primary HPWH System with Secondary Electric Resistance Trim Heater Tank and Without Hot Water Circulation

Narrative: This schematic is applicable for use with multi-pass HPWH equipment in combination with a secondary electric resistance trim tank. One or more heat pumps (compressors) may be specified. When multiple HPWHs are specified, they are piped in parallel. A thermostatic mixing valve is provided to temper the hot water supplied to the building hot water distribution system. There is no hot water circulation system present in this system configuration.

Figure 9: Multi-Pass Primary HPWH System with Trim Tank and Without Hot Water Circulation

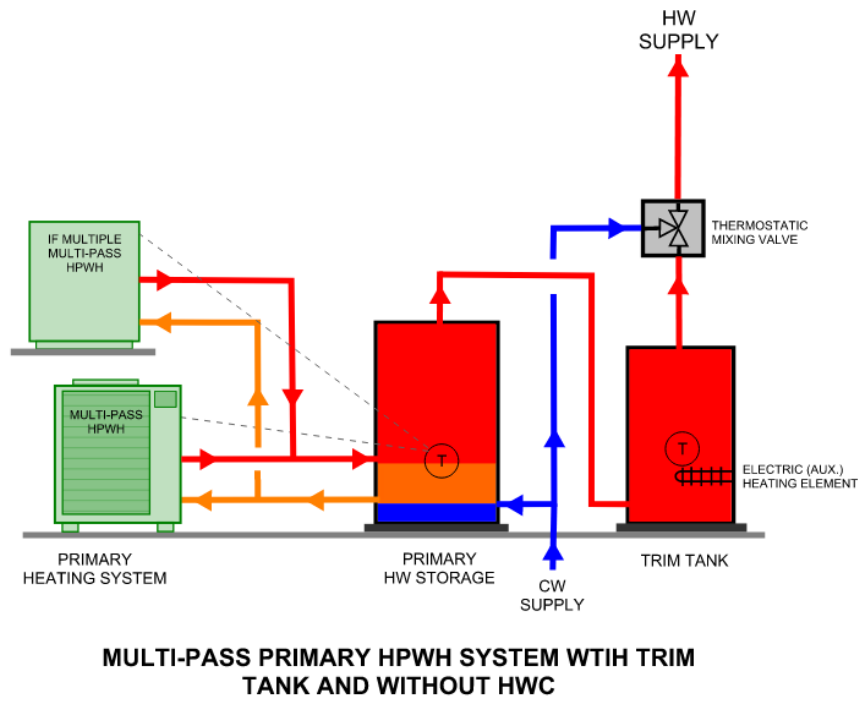

Source: California Energy Commission

Piping Configuration: Cold water is supplied to the lower portion of the storage tank. Outgoing hot water is connected to the upper portion of the storage tank and passes

APPENDIX B — Water Heating Calculation Method

through a secondary electric resistance trim tank. The multi-pass split system HPWH(s) is connected to draw water from the lower portion of the tank, heat this water about 10°F, and supply it to the middle portion of the storage tank. When multiple storage tanks are specified, the storage tanks are configured in parallel with equal flow through all parallel storage tanks. The outgoing hot water from the storage tank(s) is connected to a secondary electric water heater piped in series. The outgoing hot water connection from the secondary electric resistance heater is connected to the hot supply side of the mixing valve. A cold water connection is provided to the cold supply side of the mixing valve. The outgoing tempered side of the mixing valve is connected to the building hot water distribution piping system.

Control: The multi-pass split system HPWH(s) is controlled by a temperature sensor or multiple temperature sensors in the primary storage tank(s). Multiple parallel HPWHs are controlled in a single stage.

System Sizing: The HPWH equipment is sized to meet the domestic hot water load. Multiple HPWHs are specified when a single HPWH equipment cannot meet the load. A secondary electric resistance tank is provided for backup or redundancy and sized to meet the domestic hot water load.

Multi-Pass Integrated HPWH System with Hot Water Circulation

Narrative: This schematic is applicable for use with integrated HPWH equipment. One or more integrated HPWHs (compressors) may be specified. When multiple HPWHs are specified, they are piped in parallel. A thermostatic mixing valve is provided to temper the hot water supplied to the building hot water distribution system. The return water from the hot water circulation system is piped back to the primary heating system.

Figure 10: Multi-Pass Integrated HPWH System with Hot Water Circulation Returned to Primary Storage

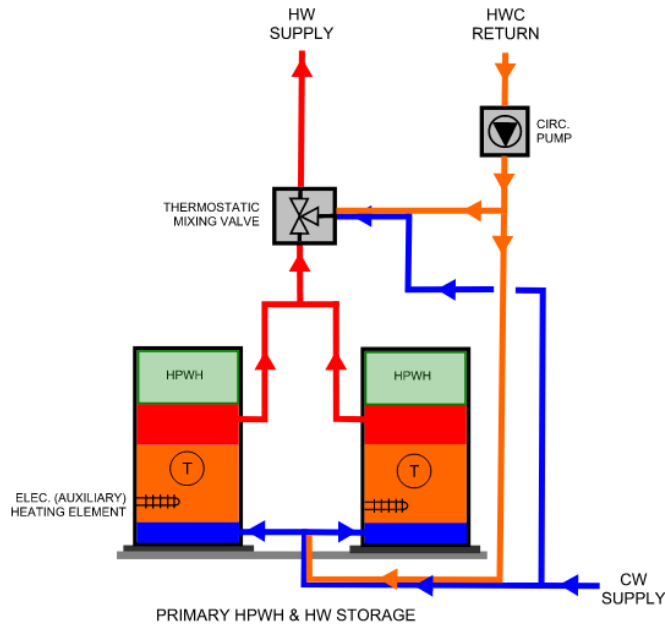

**MULTI-PASS INTEGRATED HPWH SYSTEM WITH
HW CIRCULATION RETURNED TO PRIMARY STORAGE**

Source: California Energy Commission

Piping Configuration: Cold water and return water from the hot water circulation system is supplied to the lower portion of the integrated HPWH equipment. Outgoing hot water is connected to the upper portion of the integrated HPWH equipment. When multiple integrated HPWHs are specified, the incoming cold water and return water from the hot water circulation system is supplied to the HPWH equipment, and outgoing hot water supply from the HPWH equipment is split and configured to supply equal flow to all integrated HPWH units. The outgoing hot water from the integrated HPWH(s) is connected to the hot supply side of the mixing valve. A cold water connection is provided to the cold supply side of the mixing valve. The tempered side of the mixing valve is connected to the building hot water distribution piping system.

Control: The integrated HPWH equipment is controlled by the internal equipment control system to prioritize compressor heating energy use and minimize auxiliary electric resistance heating energy use.

System Sizing: The integrated HPWH equipment is sized to meet the primary and temperature maintenance domestic hot water loads. Multiple integrated HPWHs are specified when a single integrated HPWH equipment cannot meet the load.

Multi-Pass Integrated HPWH System with Hot Water Circulation Returned to Parallel HPWH

Narrative: This schematic is applicable for use with integrated HPWH equipment serving the primary heating load in combination with a dedicated integrated HPWH in parallel to serve the temperature maintenance hot water circulation load. One or more integrated HPWHs (compressors) may be specified. When multiple HPWHs are specified, they are piped in parallel. A dedicated integrated HPWH is configured in parallel with the primary HPWHs to treat the temperature maintenance load. The return water from the hot water circulation system is fed directly to the dedicated temperature maintenance HPWH. A thermostatic mixing valve is provided to temper the hot water supplied to the building hot water distribution system.

Figure 11: Multi-Pass Integrated HPWH System with Hot Water Circulation Returned to Parallel HPWH

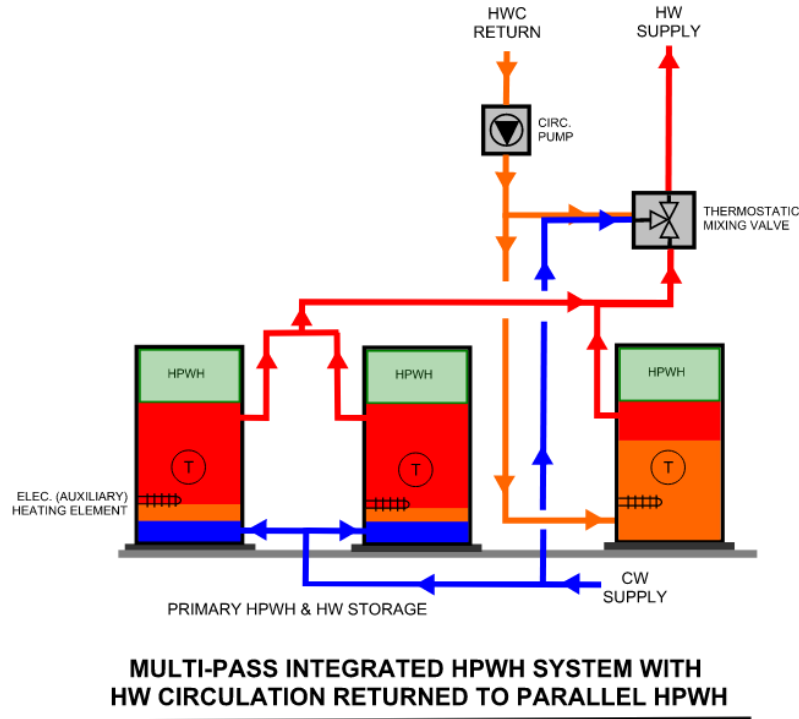

Source: California Energy Commission

Piping Configuration: Cold water is supplied to the lower portion of the integrated HPWH. Outgoing hot water is connected to the upper portion of the integrated HPWH. When multiple integrated HPWHs are specified to serve the primary heating load, the HPWHs are configured in parallel to supply equal flow rates through all integrated HPWH units. The outgoing hot water from the integrated HPWH(s) is connected to the hot supply side of the mixing valve. A dedicated integrated HPWH is configured in parallel with the primary HPWHs and serves the temperature maintenance load from the hot water circulation system. The two systems are piped together before connecting to the hot supply side of the thermostatic mixing valve. A cold water connection is provided to the cold supply side of the mixing valve. The tempered side of the mixing valve is connected to the building hot water distribution piping system.

Control: The integrated HPWH equipment is controlled by the internal equipment control system to prioritize compressor heating energy use and minimize auxiliary electric resistance heating energy use.

System Sizing: The integrated HPWH equipment is sized to meet the primary domestic hot water load. A dedicated integrated HPWH is also provided and sized to meet the

temperature maintenance hot water circulation load. Multiple integrated HPWHs are specified when a single integrated HPWH equipment cannot meet the load.

Multi-Pass Integrated HPWH System with Hot Water Circulation Returned to Series Temperature Maintenance Tank

Narrative: This schematic is applicable for use with integrated HPWH equipment serving the primary heating load in combination with a dedicated in-series temperature maintenance tank (swing tank) to serve hot water circulation load. One or more integrated HPWHs (compressors) may be specified and are be piped in parallel. When multiple HPWHs are specified, they are piped in parallel. A dedicated electric water heater (swing tank) is configured in series with the primary HPWHs to treat the temperature maintenance load. The return water from the hot water circulation system is fed directly to the dedicated temperature maintenance tank. A thermostatic mixing valve is provided to temper the hot water supplied to the building hot water distribution system.

Figure 12: Multi-Pass Integrated HPWH System with Hot Water Circulation Returned to Series Temperature Maintenance Tank

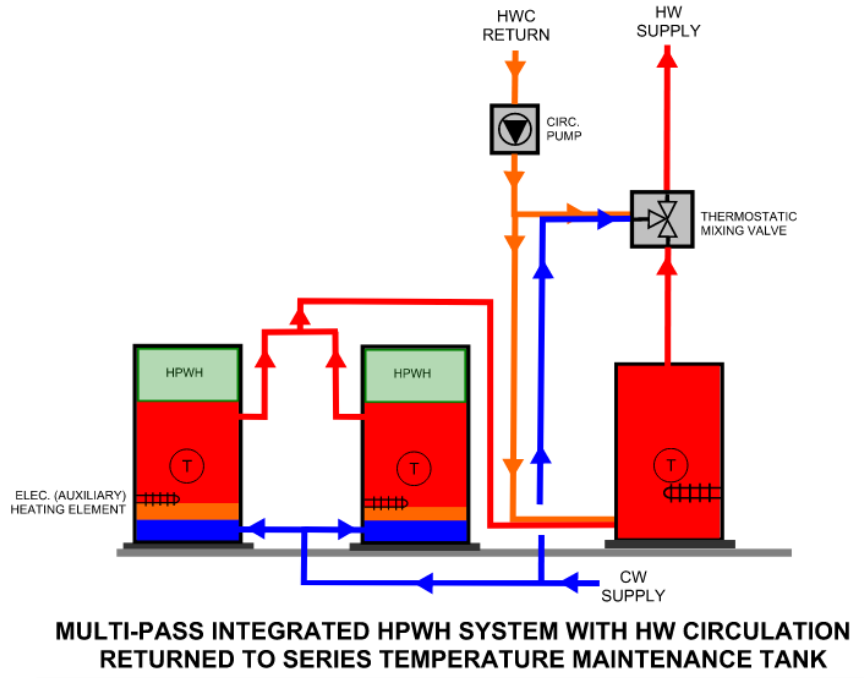

Source: California Energy Commission

Piping Configuration: Cold water is supplied to the lower portion of the integrated HPWH equipment. Outgoing hot water is connected to the upper portion of the integrated HPWH equipment. When multiple integrated HPWHs are specified to serve the primary heating load, the HPWHs are configured in parallel to supply equal flow rates through all integrated HPWH units. The outgoing hot water from the integrated HPWH(s) is connected to the bottom of the temperature maintenance tank (swing tank) so that it is in series with the

APPENDIX B — Water Heating Calculation Method

primary system. The hot water outlet of the temperature maintenance tank (swing tank) is connected to the hot supply side of the mixing valve. A cold water connection is provided to the cold supply side of the mixing valve. The tempered side of the mixing valve is connected to the building hot water distribution piping system.

Control: The integrated HPWH equipment is controlled by the internal equipment control system to prioritize compressor heating energy use and minimize auxiliary electric resistance heating energy use. The temperature maintenance tank includes an electric resistance heat element and is controlled by the internal electric water heater control system.

System Sizing: The integrated HPWH equipment is sized to meet the primary and temperature maintenance hot water domestic hot water load. The dedicated in series temperature maintenance tank is sized to meet the hot water circulation load. Multiple integrated HPWHs are specified when a single integrated HPWH equipment cannot meet the load.

Multi-Pass Integrated HPWH System with Hot Water Circulation Returned to Series Integrated HPWH

Narrative: This schematic is applicable for use with integrated HPWH equipment serving the primary heating load in combination with a dedicated in-series integrated HPWH to serve hot water circulation load. One or more integrated HPWHs (compressors) may be specified. When multiple HPWHs are specified, they are piped in parallel. A dedicated integrated HPWH is configured in series with the primary HPWHs to treat the temperature maintenance load. The return water from the hot water circulation system is fed directly to the dedicated temperature maintenance tank. A thermostatic mixing valve is provided to temper the hot water supplied to the building hot water distribution system.

Figure 13: Multi-Pass Integrated HPWH System with Hot Water Circulation Returned to Series HPWH

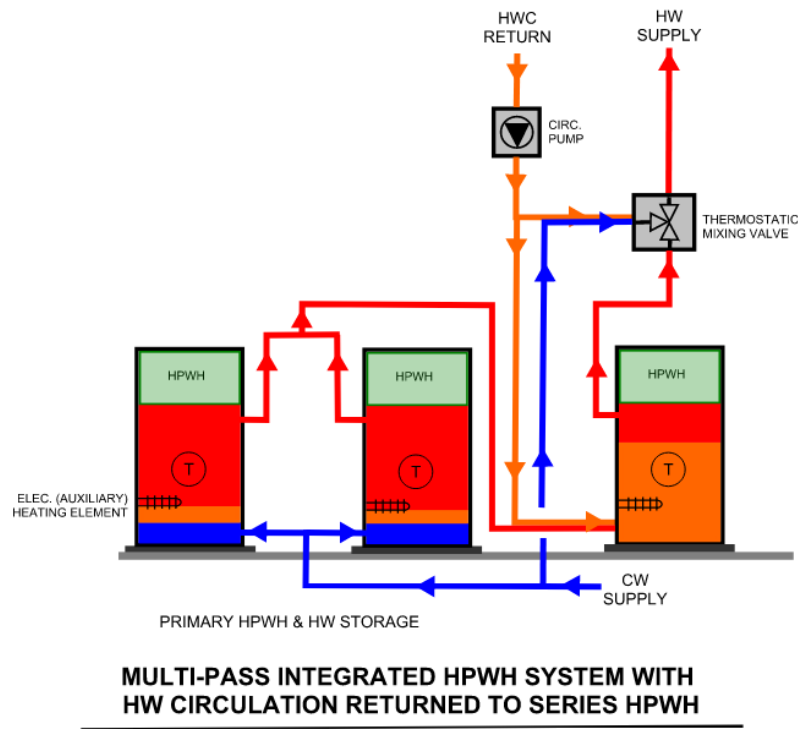

Source: California Energy Commission

Piping Configuration: Cold water and return water from the hot water circulation system is supplied to the lower portion of the integrated HPWH equipment. Outgoing hot water is connected to the upper portion of the integrated HPWH equipment. When multiple integrated HPWHs are specified to serve the primary heating load, the HPWHs are configured in parallel to supply equal flow rates through all integrated HPWH units. The outgoing hot water from the integrated HPWH(s) is connected to the bottom of the temperature maintenance HPWH so that it is in series with the primary system. The hot water outlet of the temperature maintenance tank (swing tank) is connected to the hot supply side of the mixing valve. A cold water connection is provided to the cold supply side of the mixing valve. The tempered side of the mixing valve is connected to the building hot water distribution piping system.

Control: The integrated HPWH equipment is controlled by the internal equipment control system to prioritize compressor heating energy use and minimize auxiliary electric resistance heating energy use. The temperature maintenance integrated HPWH is controlled by the internal HPWH control system.

System Sizing: The integrated HPWH equipment is sized to meet the primary and temperature maintenance hot water domestic hot water load. The dedicated in-series integrated HPWH is sized to meet the hot water circulation load. Multiple integrated HPWHs are specified when a single integrated HPWH equipment cannot meet the load.

Single-Pass HPWH System with Hot Water Circulation Returned to Primary System

Narrative: This schematic is applicable for use with split system single-pass HPWHs. One or more split system single-pass HPWHs (compressors) may be specified. When multiple HPWHs are specified, they are piped in parallel. The return water from the hot water circulation system is fed back to the primary storage tank(s). A thermostatic mixing valve is provided to temper the hot water supplied to the building hot water distribution system.

Figure 14: Single-Pass Primary HPWH System with Hot Water Circulation Returned to Primary

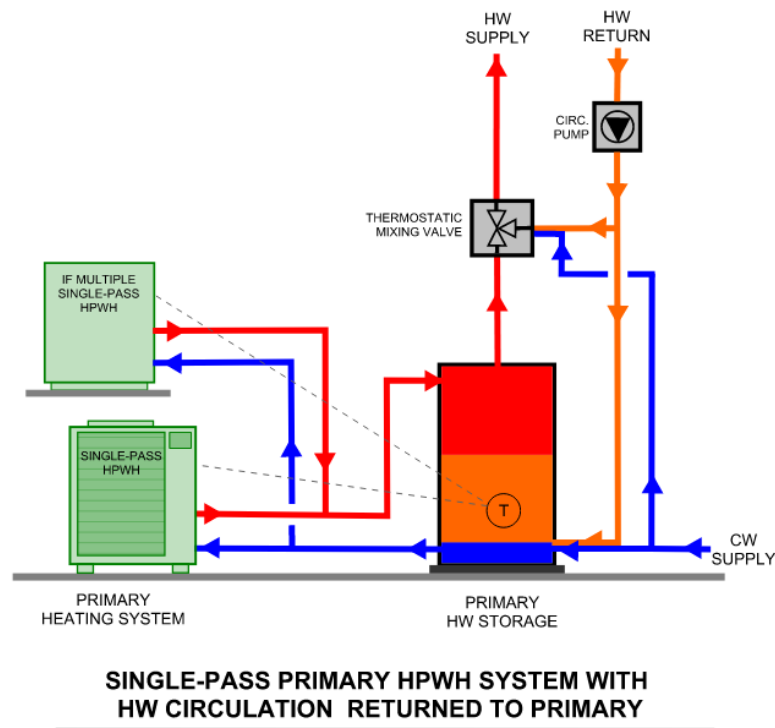

Source: California Energy Commission

Piping Configuration: Cold water is supplied to the lower portion of the primary storage tank(s). The primary single-pass HPWHs pull water from the lower portion of the primary storage tank(s) and supply hot water to the top of the primary storage tank(s). When multiple split system single-pass HPWHs are specified to serve the primary heating load, the HPWHs are configured in parallel. The return water from the hot water circulation system is connected to the bottom of the primary storage tank(s). The hot water outlet of the primary storage tank(s) is connected to the hot supply side of the mixing valve. A cold water

APPENDIX B — Water Heating Calculation Method

connection and hot water circulation connection are provided to the cold supply side of the mixing valve. The tempered side of the mixing valve is connected to the building hot water distribution piping system.

Control: The split-system single-pass HPWH equipment is controlled by the internal equipment control system to prioritize compressor heating energy use.

System Sizing: The split-system single-pass HPWH equipment is sized to meet the primary and temperature maintenance hot water domestic hot water load. Multiple split-system single-pass HPWHs are specified when a single integrated HPWH equipment cannot meet the load.

Single-Pass Primary HPWH System with Parallel Integrated HPWH

Narrative: This schematic is applicable for use with single-pass HPWH in combination with a parallel integrated HPWH for temperature maintenance in the hot water circulation system. One or more heat pumps (compressors) may be specified. When multiple HPWHs are specified, they are piped in parallel. A thermostatic mixing valve is provided to temper the hot water supplied to the building hot water distribution system.

Figure 15: Single-Pass Primary HPWH With Parallel Integrated HPWH

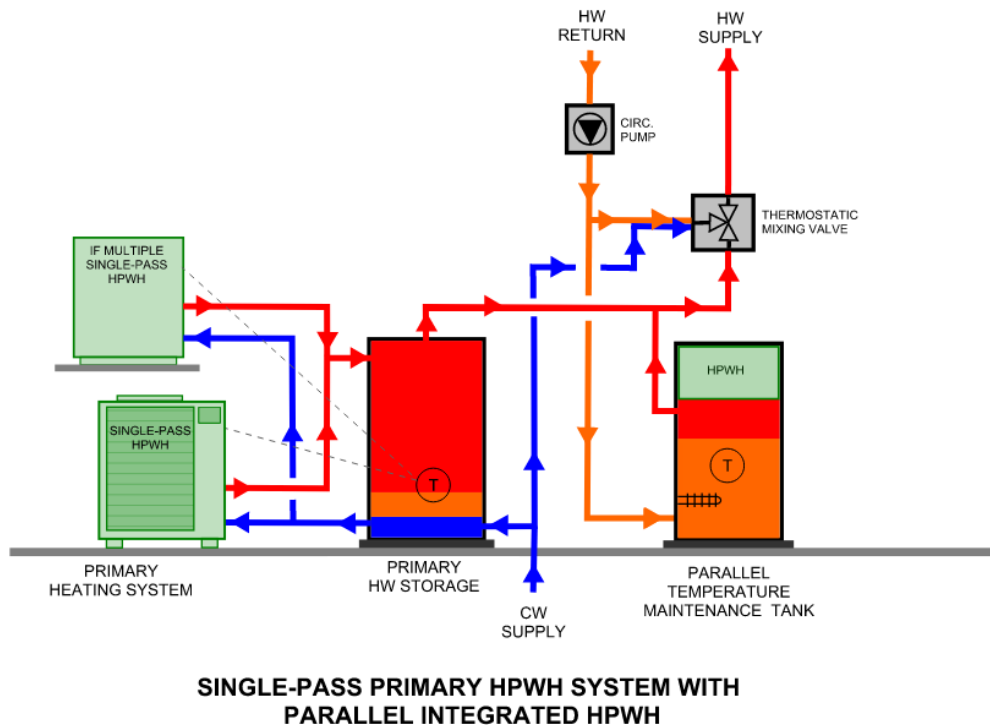

Source: California Energy Commission

Piping Configuration: Cold water is supplied to the lower portion of the storage tank. Outgoing hot water is connected to the upper portion of the storage tank and connects to the hot supply side of the thermostatic mixing valve. The single-pass split-system HPWH(s)

APPENDIX B — Water Heating Calculation Method

is connected to draw water from the lower portion of the tank, heat this water to temperature, and supply it to the upper portion of the storage tank. When multiple storage tanks are specified, the storage tanks are configured in series with the top of the first tank connected to the bottom of the second tank. This top-to-bottom connection is repeated for all storage tanks in the series. The cold water is supplied to the lower portion of the first tank, and the outgoing hot water is supplied from the upper portion of the last storage tank in series. The outgoing hot water from the storage tank (or last storage tank in series) is connected to the hot supply side of the thermostatic mixing valve. An integrated HPWH is provided for temperature maintenance to keep the hot water circulation system at the set temperature. The return water from the hot water circulation system is connected to the lower portion of the integrated HPWH. The outlet of the integrated HPWH is connected in parallel with the hot outlet from the hot water storage tank. These two water paths combine before connecting to the hot-supply side of the thermostatic mixing valve. A cold water connection and the return water from the hot water circulation system are provided to the cold-supply side of the mixing valve. The outgoing tempered side of the mixing valve is connected to the building hot water distribution piping system.

Control: The single-pass split-system HPWH(s) is controlled by a temperature sensor or multiple temperature sensors in the primary storage tank(s). Multiple parallel HPWHs are controlled in a single stage. The integrated HPWH that is part of the temperature maintenance system is controlled independently of the primary single-pass HPWH(s).

System Sizing: The HPWH equipment is sized to meet the primary domestic hot water load. Multiple HPWHs are specified when a single HPWH cannot meet the load. An integrated HPWH is sized to meet the temperature maintenance load associated with the hot water circulation system.

Single-Pass Primary HPWH System with Parallel Multi-Pass HPWH

Narrative: This schematic is applicable for use with single-pass HPWHs in combination with a parallel temperature maintenance system with multi-pass HPWH. One or more primary HPWHs (compressors) may be specified. When multiple HPWHs are specified, they are piped in parallel. A dedicated temperature maintenance system is provided to serve the hot water circulation load and is configured in parallel with the primary heating system. A thermostatic mixing valve is provided to temper the hot water supplied to the building hot water distribution system.

Figure 16: Single-Pass Primary HPWH with Parallel Temperature Maintenance Tank and Multi-Pass HPWH

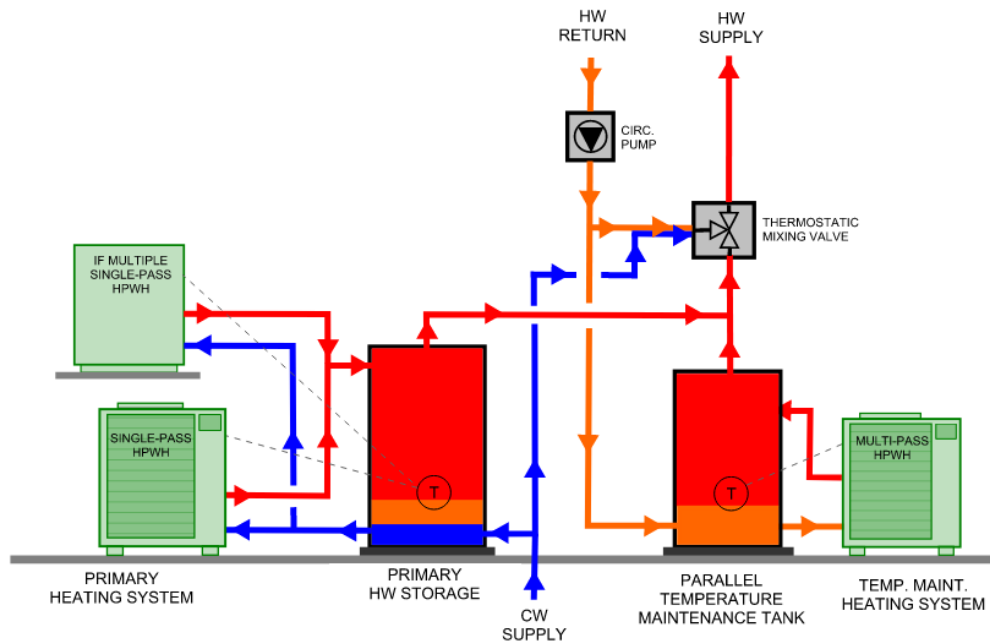

SINGLE-PASS PRIMARY HPWH SYSTEM WITH PARALLEL TEMPERATURE MAINTENANCE TANK & MULTI-PASS HPWH

Source: California Energy Commission

Piping Configuration: Cold water is supplied to the lower portion of the primary storage tank(s). Outgoing hot water is connected to the upper portion of the storage tank and to the hot-supply side of the thermostatic mixing valve. The single-pass split-system HPWH(s) is connected to draw water from the lower portion of the tank, heat this water to temperature, and supply it to the upper portion of the storage tank. A dedicated storage tank and multi-pass HPWH are provided and serve the hot water circulation temperature maintenance load. This system is configured in parallel with the primary heating system. The return water from the hot water circulation system is connected to the lower portion of the temperature maintenance storage tank. A multi-pass HPWH is connected to the dedicated temperature maintenance storage tank to provide heat to the system. The outlet of the temperature maintenance storage tank is connected in parallel with the hot outlet from the hot water storage tank so that these two water paths combine before connecting to the hot-supply side of the thermostatic mixing valve. A cold water connection and the return water from the hot water circulation system are provided to the cold supply side of the mixing valve. The outgoing tempered side of the mixing valve is connected to the building hot water distribution piping system.

Control: The single-pass split-system HPWH(s) is controlled by a temperature sensor or multiple temperature sensors in the primary storage tank(s). Multiple parallel HPWHs are

controlled in a single stage. The multi-pass HPWH that is part of the temperature maintenance system is controlled independently of the primary single-pass HPWH(s).

System Sizing: The HPWH is sized to meet the primary domestic hot water load. Multiple HPWHs are specified when a single HPWH cannot meet the load. The multi-pass HPWH is sized to meet the temperature maintenance load associated with the hot water circulation system.

Single-Pass Primary HPWH System with Series Temperature Maintenance Tank

Narrative: This configuration is used for the standard design system. This schematic is applicable for use with single-pass HPWH serving the primary heating load in combination with a dedicated in-series temperature maintenance tank (swing tank) to serve hot water circulation load. One or more single-pass HPWHs (compressors) may be specified. When multiple HPWHs are specified, they are piped in parallel. A dedicated temperature maintenance tank (swing tank) is configured in series with the primary HPWHs to treat the temperature maintenance load. The return water from the hot water circulation system is fed directly to the dedicated temperature maintenance tank. A thermostatic mixing valve is provided to temper the hot water supplied to the building hot water distribution system.

Figure 17: Single-Pass Primary HPWH with Series Temperature Maintenance Tank (Swing Tank)

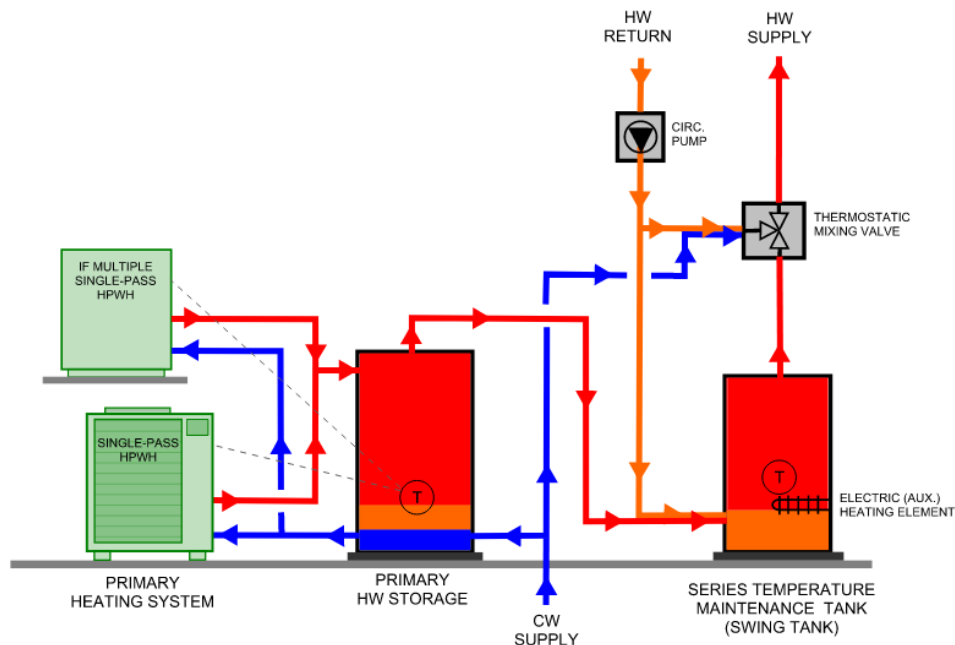

SINGLE-PASS PRIMARY HPWH SYSTEM WITH SERIES TEMPERATURE MAINTENANCE TANK (SWING TANK)

APPENDIX B — Water Heating Calculation Method

Source: California Energy Commission

Piping Configuration: Cold water is supplied to the lower portion of the primary storage tank(s). Outgoing hot water is connected to the upper portion of the primary storage tank(s). When multiple single-pass HPWHs is specified to serve the primary heating load, the HPWHs are configured in parallel. The single-pass split-system HPWH(s) are connected to draw water from the lower portion of the tank, heat this water to temperature, and supply it to the upper portion of the storage tank. A dedicated temperature maintenance tank is provided. The outgoing hot water from the primary storage is connected to the bottom of the temperature maintenance tank (swing tank) so that it is in series with the primary system. The hot water outlet of the temperature maintenance tank (swing tank) is connected to the hot supply side of the mixing valve. A cold water connection is provided to the cold-supply side of the mixing valve. The tempered side of the mixing valve is connected to the building hot water distribution piping system.

Control: The single-pass HPWH equipment is controlled by the internal equipment control system to prioritize compressor heating energy use and minimize auxiliary electric resistance heating energy use. The temperature maintenance tank includes an electric resistance heat element and is controlled by the internal electric water heater control system.

System Sizing: The single-pass HPWH equipment is sized to meet the primary and temperature maintenance hot water domestic hot water load. The dedicated in-series temperature maintenance tank is sized to meet the hot water circulation load. Multiple single-pass primary HPWHs are specified when a single HPWH cannot meet the load.

Multi-Pass HPWH System with Hot Water Circulation Returned to Primary System

Narrative: This schematic is applicable for use with split-system multi-pass HPWH equipment. One or more multi-pass HPWHs (compressors) may be specified. When multiple HPWHs are specified, they are piped in parallel. The return water from the hot water circulation system is fed back to the primary storage tank(s). A thermostatic mixing valve is provided to temper the hot water supplied to the building hot water distribution system.

Figure 18: Multi-Pass Primary HPWH System with Hot Water Return to Primary Storage

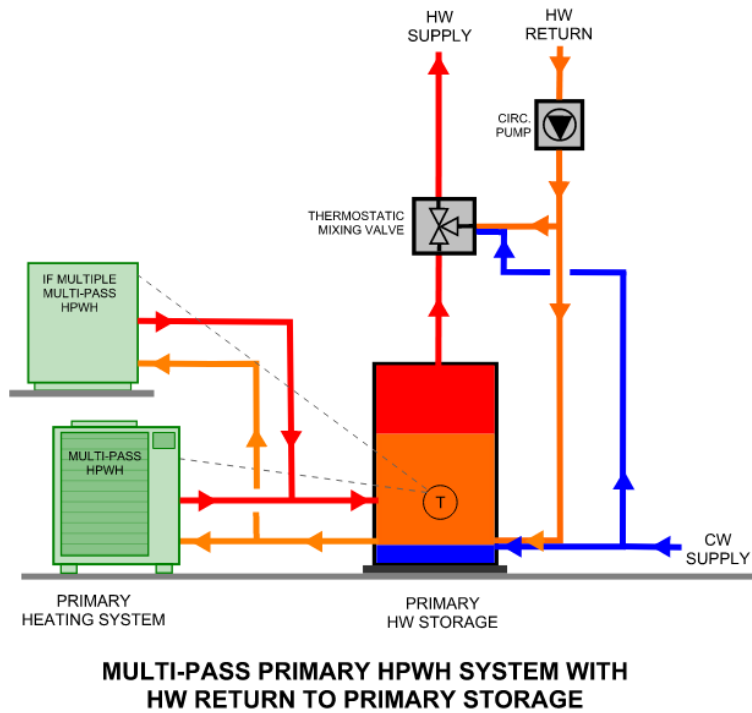

Source: California Energy Commission

Piping Configuration: Cold water is supplied to the lower portion of the primary storage tank(s). The primary multi-pass HPWHs pull water from the lower portion of the primary storage tank(s) and supply hot water to the middle portion of the primary storage tank(s). When multiple multi-pass HPWHs are specified to serve the primary and temperature maintenance heating loads, the HPWHs are configured in parallel. The return water from the hot water circulation system is connected to the bottom of the primary storage tank(s). The hot water outlet of the primary storage tank(s) is connected to the hot supply side of the mixing valve. A cold water connection and hot water circulation connection are provided to the cold supply side of the mixing valve. The tempered side of the mixing valve is connected to the building hot water distribution piping system.

Control: The split-system single-pass HPWH is controlled by the internal equipment control system to prioritize compressor heating energy use.

System Sizing: The split-system multi-pass HPWH is sized to meet the primary and temperature maintenance hot water domestic hot water load. Multiple split-system multi-pass HPWHs are specified when a single integrated HPWH equipment cannot meet the load.